

Report No: CS-MESL-2023-009

Testing Centre of Hefei Institute for Public Safety Research, THU

DETECTING AND ANALYZING REPORT

SAMPLE NAME Modular Foldable House

g DETE CTING I YTE Large Modular Housing (i nhui)n s ti n

YZI NG UNI T(st DETECTING AND ANALYZING

a mp) REPORTING DATE

Testing Centre of Hefei Institute for Public Safety Research, THU

2023.11.10

ADDRESS: No. 5999, Xiyou Road, Hefei Economic and Technological Development Zone TEL / FAX: 0551-63621262/0551-63660791

WEBSITE: <http://www.tsinghua-hf.edu.cn/> E-Mail: thtc@tsinghua-hf.edu.cn

检验检测专用章

检验检测

DECLARATION

- 1. The report without "special seal for Inspection and testing" is invalid, and the copy without "special seal for Inspection and testing" is invalid.**
- 2. Any alteration, addition or deletion of the report is invalid, incomplete seal is invalid, and the Center is not liable for any consequences caused by misunderstanding or other use of some pages.**
- 3. If there is any objection to this report from the date of completion, it will be submitted to the Center for reexamination within 15 days.**
- 4. The sample information and sample identification in this report shall be provided by the submitting party. The Center is not responsible for its authenticity, and the test results are only responsible for the submitted samples.**
- 5. The test results of this report are for internal scientific research only, and do not have the role of external proof.**
- 6. Without the consent of the Center, no entity or individual is allowed to use the name of the Center and this report as commercial advertisements.**

Testing Centre of Hefei Institute for Public Safety Research, CHU

Test Report

Test report number: CS-MESL-2023-009



Page 1 of 3

Sample Name	Modular Foldable House		Specification model	L 5.8m × W 2.5m × H 2.43m	
Entrusted Unit	Hefei Huanfeng Modular Housing (Inhui) Co., Ltd		Entrusted Unit Address	Workshop No. 2, Hefei Yangli Logistics Park, Shan'e Chang'an County, Hefei City, Anhui Province	
Testing Date	2023.11.3, 3 Representative Samples				
Sample Name and	Compressive Performance	Standard	Test Method	Testing Item	
Test Type	EDAE		Test Quantity	1	
Signature	Compressive performance evaluation, 8m ³ water tank with a water injection depth of 60cm is placed at the top of the sample				
Testing Results	The sample has been tested, and the results are detailed in the test result summary: no obvious structure damage was observed of the sample.				
Inspector	ZHU Yucheng	SIGN	ZHUYucheng		2023.11.10
Reviewer	SONG Yuhan	SIGN	SONG Yuhan		2023.11.10
			WU Jimin		2023.11.10

Testing Centre of Hefei Institute for Public Safety Research, THU
Test Report (Summary of test results)

Test report number: CS-MESL-2023-009

Page 2 of 3

Test Condition			
Sample Name	Status		
Modular Foldable House	8m ³ water tank with a water injection depth of 60cm was placed at the top of the sample		
Testing Device			
Device Name	Function	Device diagram	Remarks
Climate Wind Tunnel	Providing Test Space and Water	 <p>风洞总体尺寸: 71.6m x 27.5m x 11.2m</p> <p>风速: 1-80 m/s 温度: -45-10°C 湿度: 10%-95% RH 静压: 0-250mmHg 流量: 0-150m³/h 功率: 500-1200W/m²</p>	

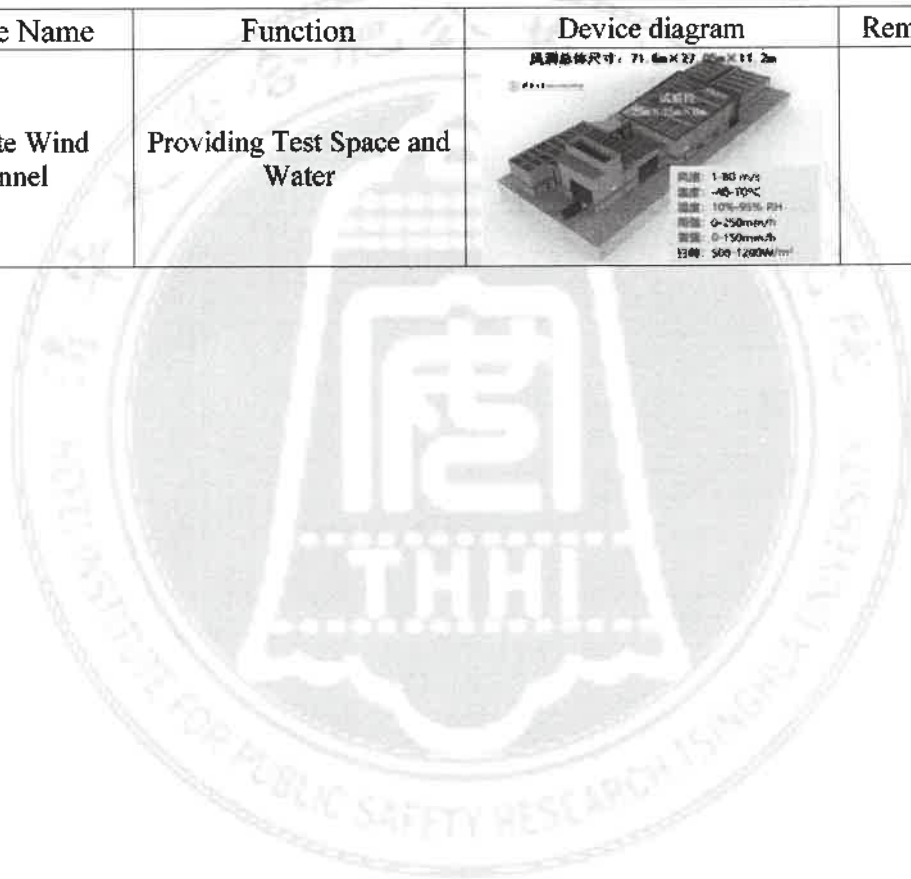

Testing Centre of Hefei Institute for Public Safety Research, THU
Test Report (Summary of test results)

Test report number: CS-MESL-2023-009

Page 3 of 3

Sample number

CS-MESL-2023-009

Test sample picture



Before the Test



Test-in-process

审核
章

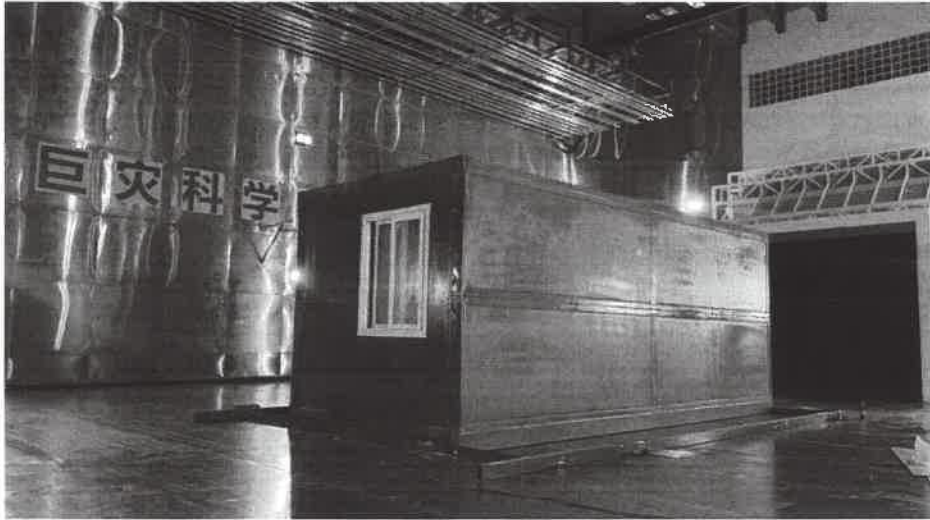

After the Test



Blank Below

Testing Centre of Hefei Institute for Public Safety Research, THU

DETECTING AND ANALYZING REPORT

SAMPLE NAME	Modular Foldable House
st i n g DETEC T I N G	E r a n d e M o d u l a r H o u s i n g (i n h u i) n T
Y Z I N G U N I T (s t	DETE CTING AND ANAL
a m p) R E P O R T I N G D A T E	
<u>Testing Centre of Hefei Institute for Public Safety Research, THU</u>	

2023.11.10

ADDRESS: No. 5999, Xiyou Road, Hefei Economic
and Technological Development Zone

TEL / FAX: 0551-63621262/0551-63660791

WEBSITE: <http://www.tsinghua-hf.edu.cn/>

E-Mail: thtc@tsinghua-hf.edu.cn



DECLARATION

- 1. The report without "special seal for Inspection and testing" is invalid, and the copy without "special seal for Inspection and-testing" is invalid.**
- 2. Any alteration, addition or deletion of the report is invalid, incomplete seal is invalid, and the Center is not liable for any consequences caused by misunderstanding or other use of some pages.**
- 3. If there is any objection to this report from the date of completion, it will be submitted to the Center for reexamination within 15 days.**
- 4. The sample information and sample identification in this report shall be provided by the submitting party. The Center is not responsible for its authenticity, and the test results are only responsible for the submitted samples.**
- 5. The test results of this report are for internal scientific research only, and do not have the role of external proof.**
- 6. Without the consent of the Center, no entity or individual is allowed to use the name of the Center and this report as commercial advertisements.**

Testing Centre of Hefei Institute for Public Safety Research, THU
Test Report (Summary of test results)

Test report number: CS-MESL-2023-006

Page 2 of 3

Test Condition			
Sample Name	Status		
Modular Foldable House	The windward gate and windows, and the leeward windows were closed.		
Testing Device			
Device Name	Function	Device diagram	Remarks
Climate Wind Tunnel	Providing Rainfall	 <p>风洞总尺寸: 7.1 6m × 22.05m × 11.2m</p> <p>风速: 1-80 m/s 温度: -40~70°C 湿度: 10%-95% RH 降雨: 0-250mm/h 雾量: 0-150mm/h 日照: 500-1200W/m²</p>	

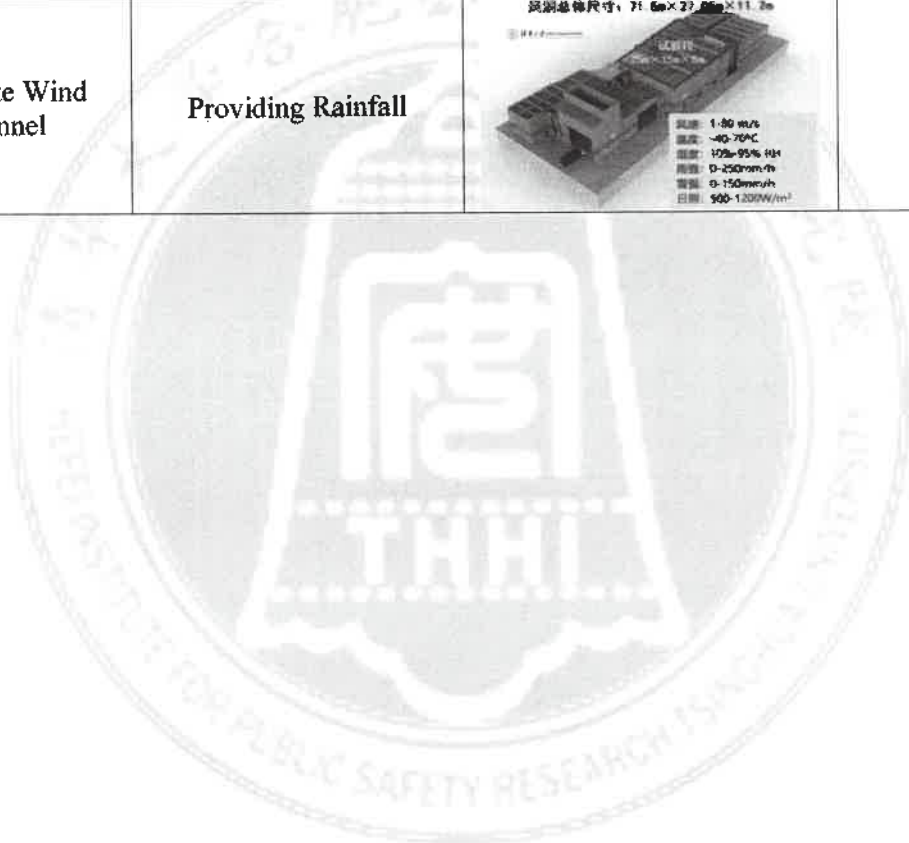

Testing Centre of Hefei Institute for Public Safety Research, THU
Test Report (Summary of test results)

Test report number: CS-MESL-2023-006

Page 3 of 3

Sample number

CS-MESL-2023-006

Test sample picture

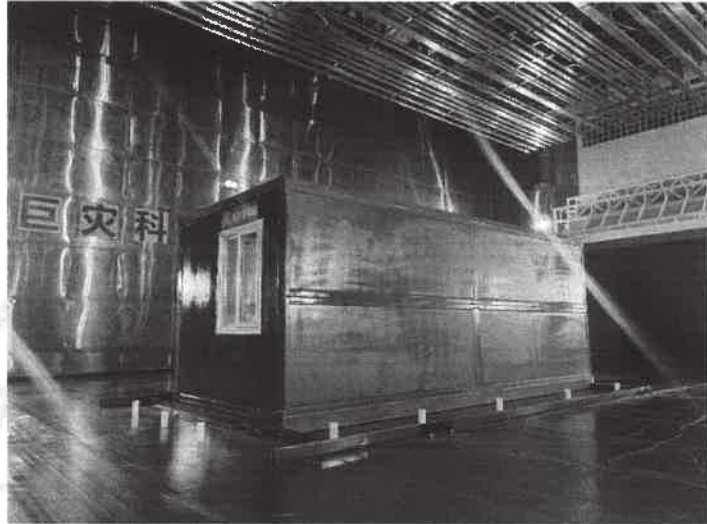

Before the Test

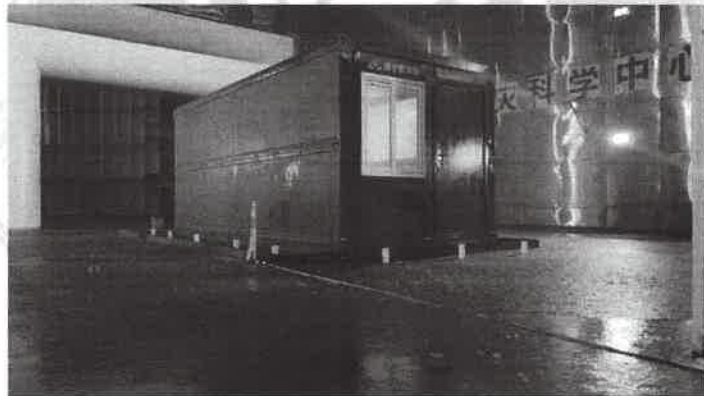

Test-in-process (rainfall intensity: 20mm/h)



Test-in-process (rainfall intensity: 30mm/h)



Test-in-process (rainfall intensity: 60mm/h)

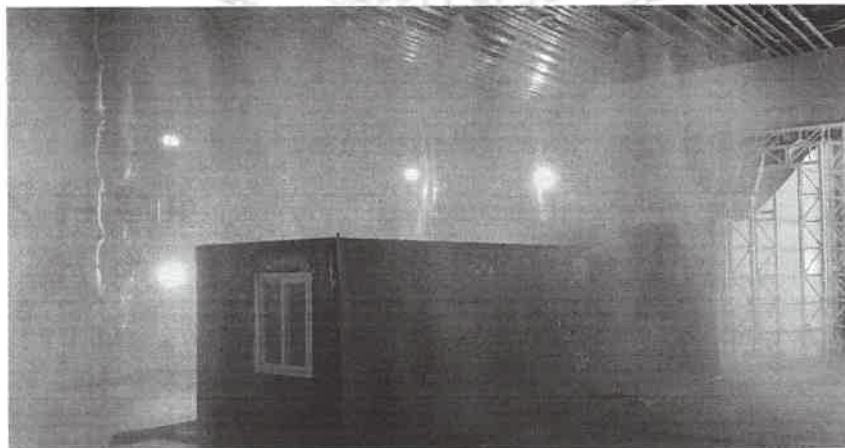

Test-in-process (rainfall intensity: 202mm/h)



After the Test

Blank Below

Testing Centre of Hefei Institute for Public Safety Research, THU

DETECTING AND ANALYZING REPORT

SAMPLE NAME Modular Foldable House

TECTI NGIYP EDE IE
Grahde Modular Hous:h
N Ahi u: oCoti LN

IG UNIT (s t a mp
CTI NG AN AYIN

) T e s t i n g C e n t r e o f H e f e i I n s t i t u t e f o
r P u b l i c S a f e t y R e s e a r c h

2023.11.10

ADDRESS: No. 5999, Xiyou Road, Hefei Economic and Technological Development Zone TEL / FAX: 0551-63621262/0551-63660791

WEBSITE: <http://www.tsinghua-hf.edu.cn/> E-Mail: thtc@tsinghua-hf.edu.cn



DECLARATION

- 1. The report without "special seal for Inspection and testing" is invalid, and the copy without "special seal for Inspection and testing" is invalid.**
- 2. Any alteration, addition or deletion of the report is invalid, incomplete seal is invalid, and the Center is not liable for any consequences caused by misunderstanding or other use of some pages.**
- 3. If there is any objection to this report from the date of completion, it will be submitted to the Center for reexamination within 15 days.**
- 4. The sample information and sample identification in this report shall be provided by the submitting party. The Center is not responsible for its authenticity, and the test results are only responsible for the submitted samples.**
- 5. The test results of this report are for internal scientific research only, and do not have the role of external proof.**
- 6. Without the consent of the Center, no entity or individual is allowed to use the name of the Center and this report as commercial advertisements.**

Testing Centre of Hefei Institute for Public Safety Research, THU
Test Report (Summary of test results)

Test report number: CS-MESL-2023-008

Page 2 of 3

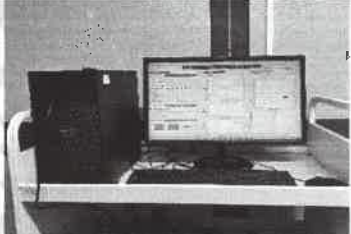
Test Condition			
Sample Name	Status		
Modular Foldable House	The windward gate and windows, and the leeward windows were closed.		
Testing Device			
Device Name	Function	Device diagram	Remarks
Climate Wind Tunnel	Providing Low-Temperature Environment	 <p>规格型号尺寸: 71.5m×27.0m×11.2m 风量: 1-80 m³/s 温度: -40-40°C 湿度: 10%-95% RH 风速: 0-250m/s 噪音: 0-150m/s² 功耗: 300-1200kW</p>	
Temperature Data Acquisition System	Collect Temperature Data During the Experiment		

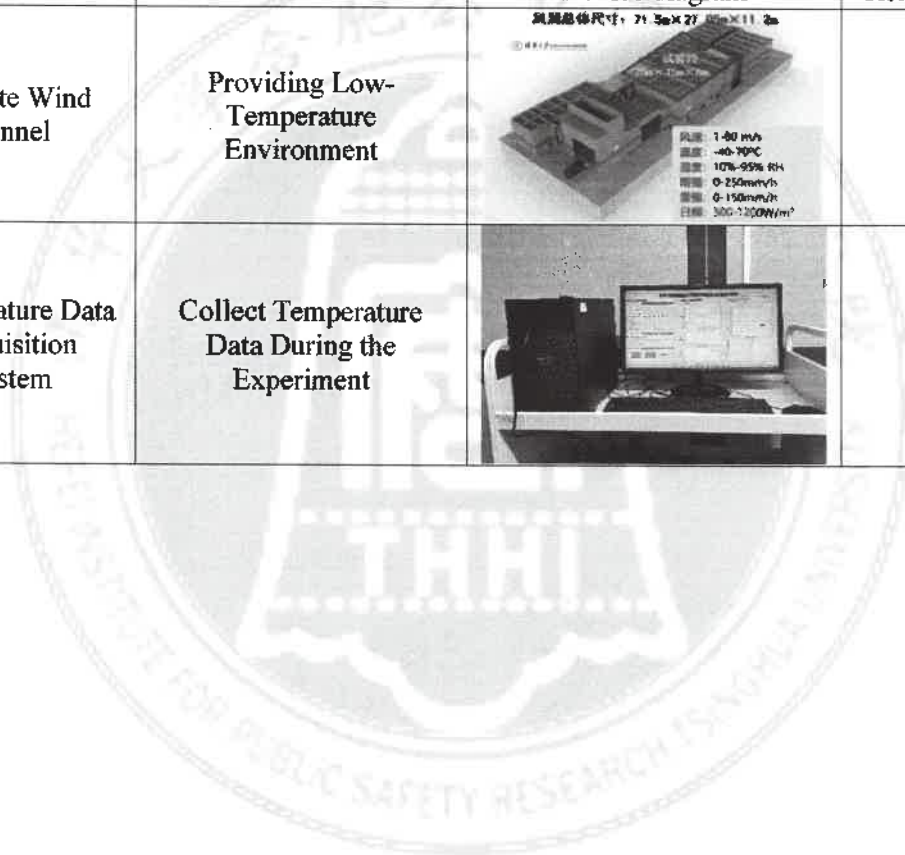

Test Report (Summary of test results)

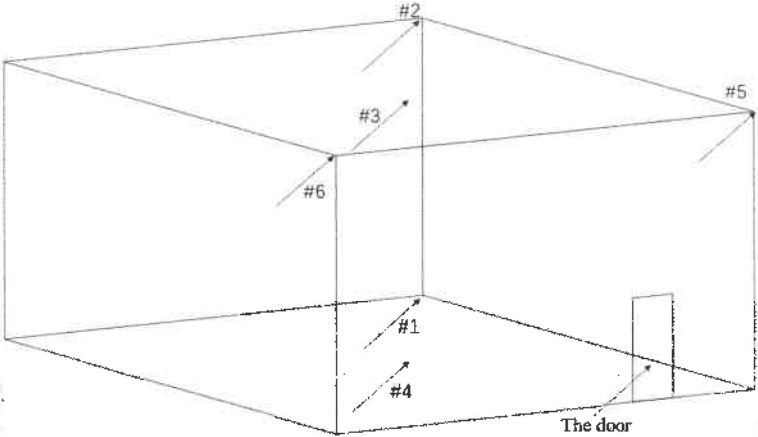
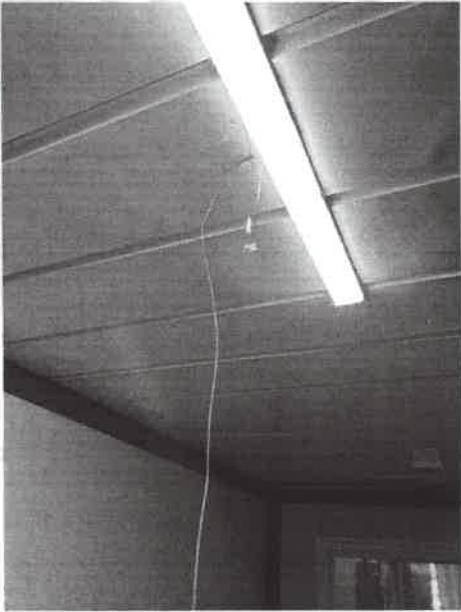
Sample number	CS-MESL-2023-008
Test sample picture	
 <p data-bbox="539 981 1102 1012">Temperature Measuring Point Arrangement</p>  <p data-bbox="651 1655 997 1686">Testing Point Arrangement</p>	

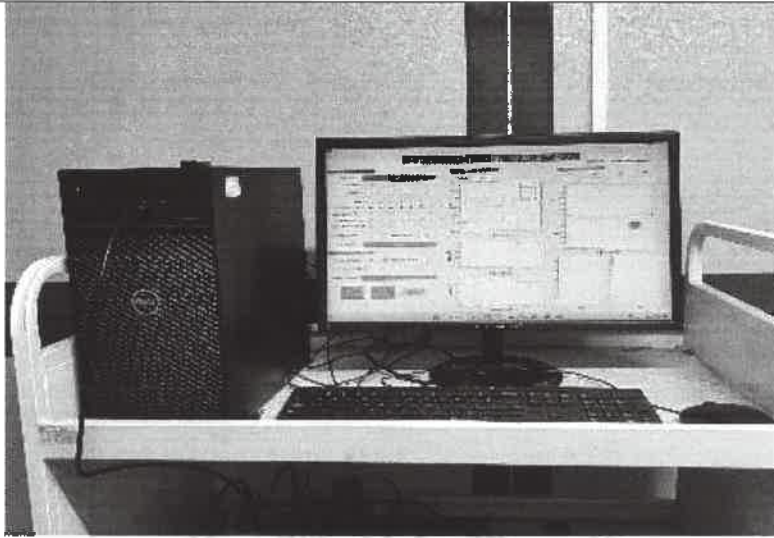

Before the Test



Test-in-process(-30°C)

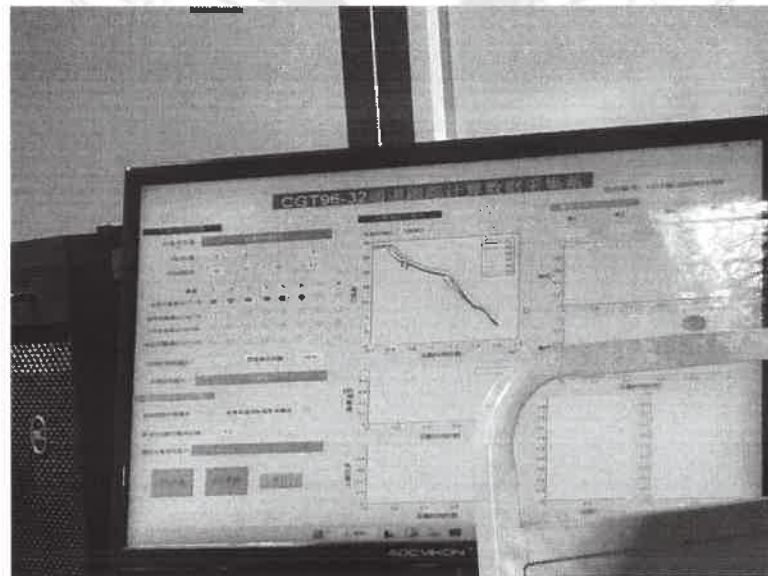

After the Test

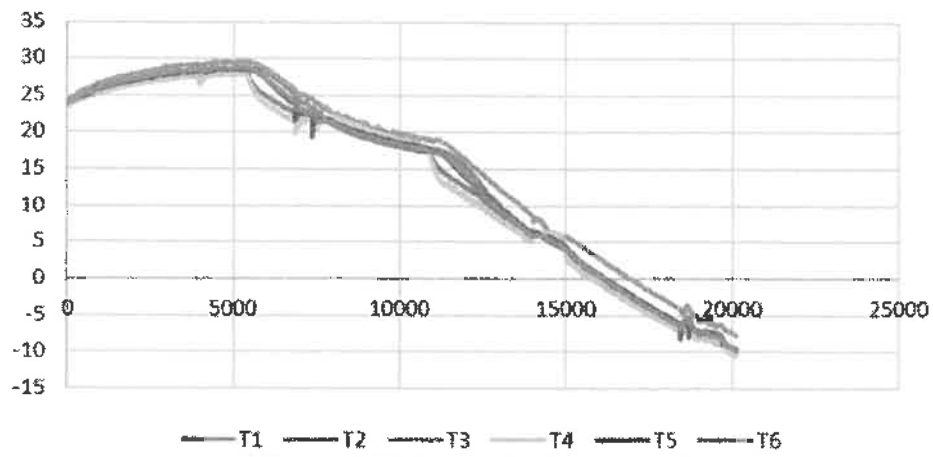

Annex 1: Temperature of measurement points after 1.5 hours test in -30°C environment.

Measurement point	#1	#2	#3	#4	#5	#6
Temperature	-10.4°C	-9.9°C	-7.9°C	-10.3°C	-9.6°C	-9.7°C

Blank Below

Report No: CS-MESL-2023-007

Testing Centre of Hefei Institute for Public Safety Research, THU

DETECTING AND ANALYZING REPORT

SAMPLE NAME	Modular Foldable House
ENTRUSTING UNIT	Anhui Zeyu Color Steel Structure Co., Ltd.
DETECTING TYPE	Commission Testing

DETECTING AND ANALYZING UNIT (stamp)

Testing Centre of Hefei Institute for Public Safety Research, THU

REPORTING DATE: 2023.11.10

ADDRESS: No. 5999, Xiyou Road, Hefei Economic
and Technological Development Zone

TEL / FAX: 0551-63621262/0551-63660791

WEBSITE: <http://www.tsinghua-hf.edu.cn/>

E-Mail: thtc@tsinghua-hf.edu.cn



DECLARATION

- 1. The report without "special seal for Inspection and testing" is invalid, and the copy without "special seal for Inspection and testing" is invalid.**
- 2. Any alteration, addition or deletion of the report is invalid, incomplete seal is invalid, and the Center is not liable for any consequences caused by misunderstanding or other use of some pages.**
- 3. If there is any objection to this report from the date of completion, it will be submitted to the Center for reexamination within 15 days.**
- 4. The sample information and sample identification in this report shall be provided by the submitting party. The Center is not responsible for its authenticity, and the test results are only responsible for the submitted samples.**
- 5. The test results of this report are for internal scientific research only, and do not have the role of external proof.**
- 6. Without the consent of the Center, no entity or individual is allowed to use the name of the Center and this report as commercial advertisements.**

Testing Centre of Hefei Institute for Public Safety Research, THU

Test Report

Test report number: CS-MESL-2023-007



Page 1 of 3

Sample Name	Modular Foldable House	Specification model	L 5.8m × W 2.5m × H 2.43m		
Entrusted unit Name	Anhui Zeyu Color Steel Structure Co., Ltd.	Entrusted unit Address	Workshop No.2, Hongyang Logistics Yard, Tushan Street, Gangji Town, Changfeng County, Hefei City, Anhui Province		
Testing Device	Climate Wind Tunnel				
Testing Purpose	Weatherproof Performance	Testing Date	2023.10.26		
Sample Status	Intact	Sample Quantity	1		
Testing Items and Testing Types	Weatherproof performance test, rainfall intensity: $\leq 40\text{mm/h}$, wind speed: 10m/s				
Testing Results	<p>The sample has been tested, and the results are detailed in the test result summary.</p> <p>1. Rain intensity of 27mm/h and wind speed of 10m/s: no obvious rain leakage was observed in the sample.</p> <p>2. Rain intensity of 40mm/h and wind speed of 10m/s: slight rain leakage appeared at the bottom corner of the gate; no obvious leakage was observed in other parts of the sample.</p>				
Chief Inspector	ZHU Yucheng	SIGN	<i>ZHU Yucheng</i>	DATE	2023.11.10
Reviewer	SONG Yuhan	SIGN	<i>Song Yuhan</i>	DATE	2023.11.10
Approver	WU Jinmo	SIGN	<i>WU Jinmo</i>	DATE	2023.11.10

Testing Centre of Hefei Institute for Public Safety Research, THU
Test Report (Summary of test results)

Test report number: CS-MESL-2023-007

Page 2 of 3

Test Condition			
Sample Name	Status		
Modular Foldable House	The windward gate and windows, and the leeward windows were closed.		
Testing Device			
Device Name	Function	Device diagram	Remarks
Climate Wind Tunnel	Providing Rainfall	 <p> 风洞总尺寸: 71.2m x 77.0m x 11.2m 风速: 1-80 m/s 温度: -40-70°C 湿度: 10%-95% RH 降雨: 0-250mm/h 风速: 0-150mm/h 日期: 500-1200h/cm² </p>	

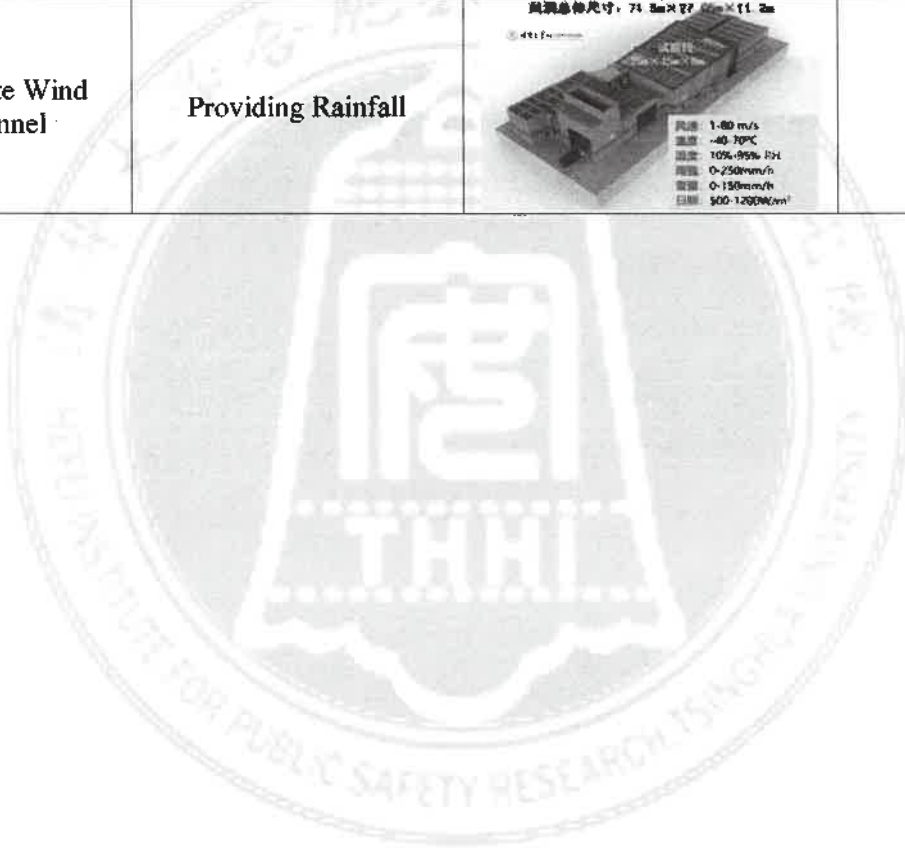

Testing Centre of Hefei Institute for Public Safety Research, THU
Test Report (Summary of test results)

Test report number: CS-MESL-2023-007

Page 3 of 3

Sample number

CS-MESL-2023-007

Test sample picture

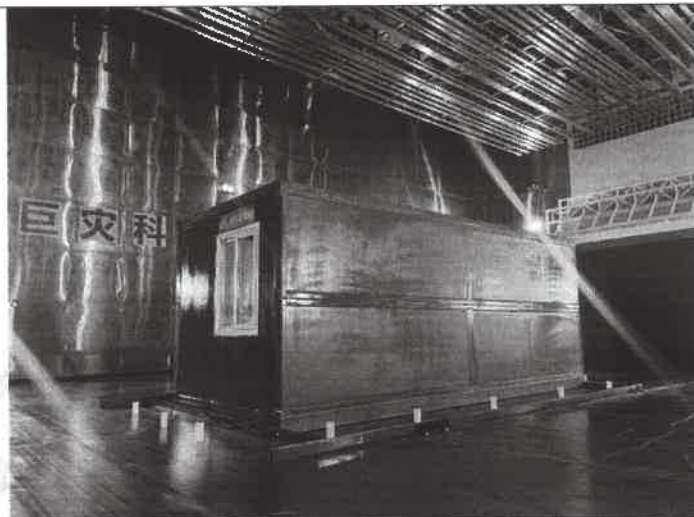

Before the Test



Test-in-process (rainfall intensity: 27mm/h, wind speed: 10m/s)



Test-in-process (rainfall intensity: 40mm/h, wind speed: 10m/s)



**The bottom corner on the right side of the sample gate
(rainfall intensity: 40mm/h, wind speed: 10m/s)**



After the Test

Blank Below

Report No: CS-MESL-2023-005

Testing Centre of Hefei Institute for Public Safety Research, THU

DETECTING AND ANALYZING REPORT

SAMPLE NAME	Modular Foldable House
ENTRUSTING UNIT	Anhui Zeyu Color Steel Structure Co., Ltd.
DETECTING TYPE	Commission Testing

DETECTING AND ANALYZING UNIT (stamp)

Testing Centre of Hefei Institute for Public Safety Research, THU

REPORTING DATE:

2023.11.10

ADDRESS: No. 5999, Xiyou Road, Hefei Economic
and Technological Development Zone

TEL / FAX: 0551-63621262/0551-63660791

WEBSITE: <http://www.tsinghua-hf.edu.cn/>

E-Mail: thtc@tsinghua-hf.edu.cn



DECLARATION

- 1. The report without "special seal for Inspection and testing" is invalid, and the copy without "special seal for Inspection and testing" is invalid.**
- 2. Any alteration, addition or deletion of the report is invalid, incomplete seal is invalid, and the Center is not liable for any consequences caused by misunderstanding or other use of some pages.**
- 3. If there is any objection to this report from the date of completion, it will be submitted to the Center for reexamination within 15 days.**
- 4. The sample information and sample identification in this report shall be provided by the submitting party. The Center is not responsible for its authenticity, and the test results are only responsible for the submitted samples.**
- 5. The test results of this report are for internal scientific research only, and do not have the role of external proof.**
- 6. Without the consent of the Center, no entity or individual is allowed to use the name of the Center and this report as commercial advertisements.**

Testing Centre of Hefei Institute for Public Safety Research, THU

Test Report

Test report number: CS-MESL-2023-005



Page 1 of 3

Sample Name	Modular Foldable House	Specification model	L 5.8m × W 2.5m × H 2.43m	
Entrusted unit Name	Anhui Zeyu Color Steel Structure Co., Ltd.	Entrusted unit Address	Workshop No.2, Hongyang Logistics Yard, Tushan Street, Gangji Town, Changfeng County, Hefei City, Anhui Province	
Testing Device	Climate Wind Tunnel			
Testing Purpose	Wind-Resistant Performance	Testing Date	2023.11.02	
Sample Status	Intact	Sample Quantity	1	
Testing Items and Testing Types	Wind-resistant performance test, wind speed: ≤ 56.3m/s.			
Testing Results	<p>The sample has been tested, and the results are detailed in the test result summary.</p> <ol style="list-style-type: none"> Wind speed of 37.7 m/s (level 13): no obvious abnormalities were observed in the sample. Wind speed of 41.5m/s (level 14): the sample gate was blown open; no obvious abnormalities were observed in other parts of the sample. Wind speed of 49.9m/s (level 15) and the gate had been welded: the gate deformed; no obvious abnormalities were observed in other parts of the sample. Wind speed of 56.3m/s (level 17) and the gate had been reinforced: no obvious abnormalities were observed in the sample. 			
Chief Inspector	ZHU Yucheng	SIGN	<i>ZHU Yucheng</i>	DATE 2023.11.10
Reviewer	SONG Yuhan	SIGN	<i>SONG Yuhan</i>	DATE 2023.11.10
Approver	WU Jinmo	SIGN	<i>WU Jinmo</i>	DATE 2023.11.10

Testing Centre of Hefei Institute for Public Safety Research, THU
Test Report (Summary of test results)

Test report number: CS-MESL-2023-005

Page 2 of 3

Test Condition			
Sample Name	Status		
Modular Foldable House	The windward gate and windows were closed. The leeward windows were open.		
Testing Device			
Device Name	Function	Device diagram	Remarks
Climate Wind Tunnel	Providing Wind	 <p>风洞总体尺寸: 71.5m×27.0m×11.2m 444</p> <p> 风速: 1-80 m/s 温度: -40-70°C 湿度: 10%-95% RH 噪声: 0-250dB(A) 流量: 0-150m³/s 功率: 500-1200kW </p>	

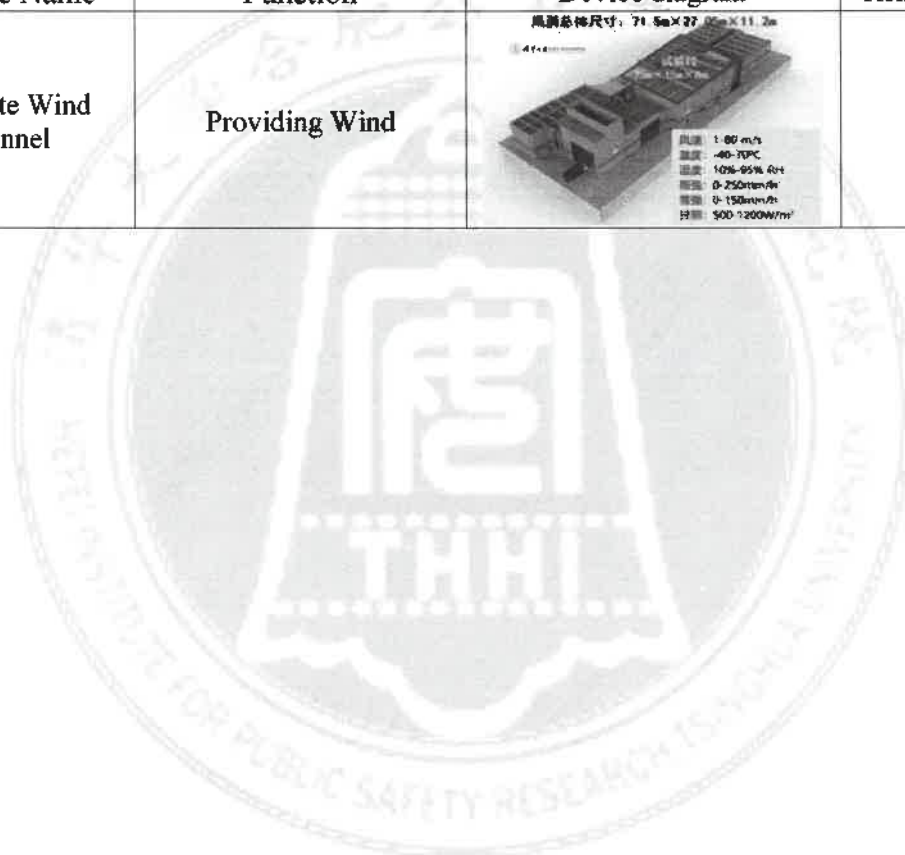

Testing Centre of Hefei Institute for Public Safety Research, THU
Test Report (Summary of test results)

Test report number: CS-MESL-2023-005

Page 3 of 3

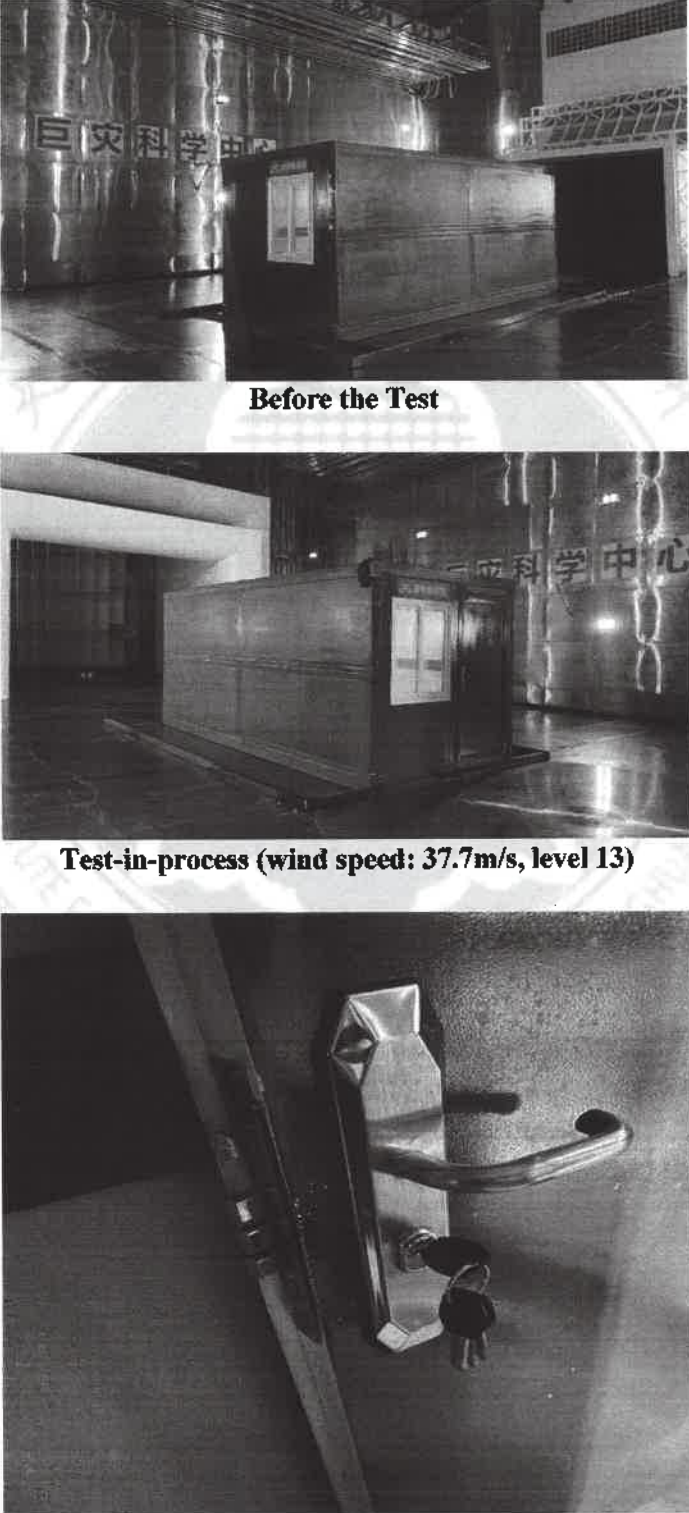
Sample number	CS-MESL-2023-005
Test sample picture	
 <p data-bbox="722 880 916 909">Before the Test</p> <p data-bbox="533 1337 1110 1366">Test-in-process (wind speed: 37.7m/s, level 13)</p> <p data-bbox="533 2011 1110 2040">Test-in-process (wind speed: 41.5m/s, level 14)</p>	



Test-in-process (wind speed: 41.5m/s, level 14)

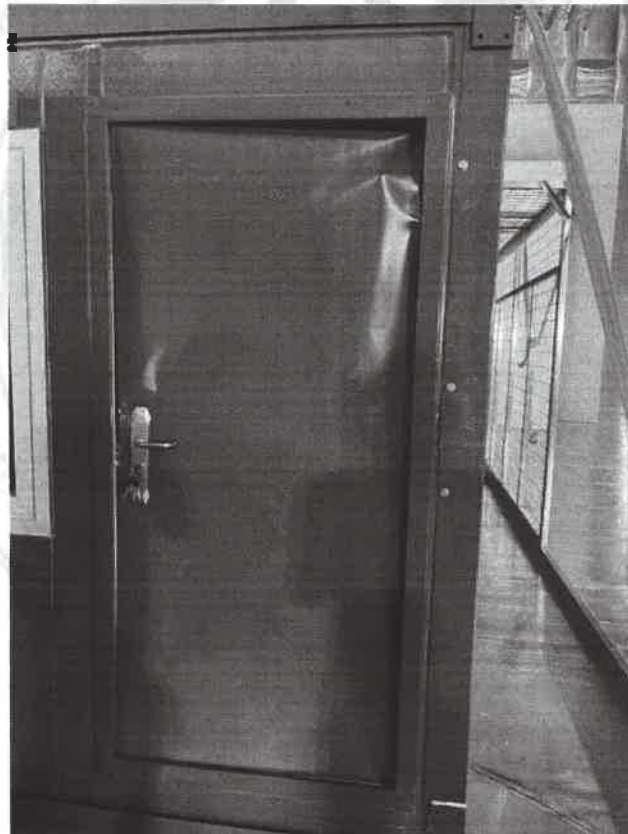

Test-in-process (wind speed: 49.9m/s, level 15)

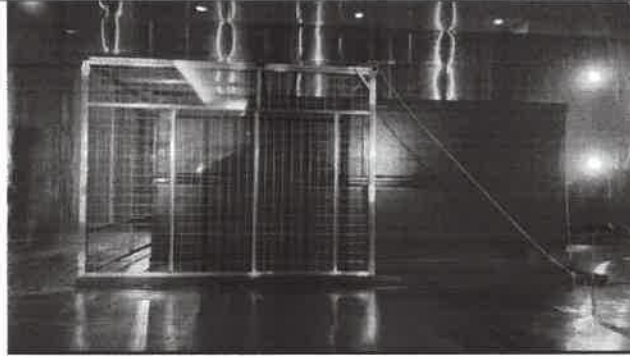

Test-in-process (wind speed: 56.3m/s, level 17)



After the Test

Blank Below
