



GREAT GRANDE

GRANDE MODULAR HOUSING(ANHUI)CO.,LTD

Tel / Whatsapp: +86 19314030287

Web: www.grande-house.com

**Prefab Modular
Container House**



Prefab Modular Container House



Grande House

01	Prefab Modular Container House.....	00
	Company profile.....	01
	Certificate.....	03

02	Expandable Container House.....	07
	10 FT Expandable container.....	08
	20 FT Expandable container house.....	11
	20 FT Two-storey.....	15
	30 FT Expandable container.....	19
	40 FT Expandable container.....	23
	700 Model expandable container house.....	31
	Project case.....	35
	Packing&Shipping.....	37
	Steps.....	38

03	Folding Container House.....	39
	Foldable container house.....	40
	Portable container house.....	51
	Project case.....	61
	Packing&Shipping.....	65
	Material.....	67
	Kitchen.....	71
	Bathroom.....	73
	Door&Window.....	75
	Terrace.....	77
	Outdoor toilet.....	79

04	Space Capsule.....	80
	Space capsule.....	81
	Apple cabin.....	83
	Triangle house.....	85

Company profile

Grande modular housing (Anhui) Co., Ltd. is an innovative manufacturer of prefabricated houses. Standing at the forefront of the industry, the company perfectly combines research and development, manufacturing, sales and service to meet different customer needs.

The products offer a diverse range of customized and innovative products that lead the industry in terms of quality, safety and durability.

The company has material testing reports and system certifications from different countries, including ISO9001, EU CE and Environmental Management System. We have CE, ASTM, BV, ISO, UL and SGS quality certifications.

Company Mission: To serve global customers with superior quality and lean manufacturing.





Certificate



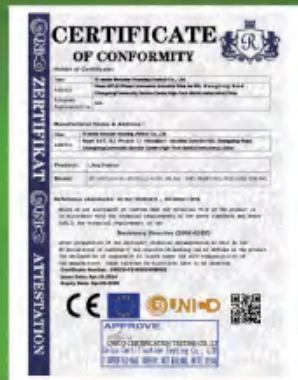

10 FT Expandable container

Expandable Container House

Prefab modular container house

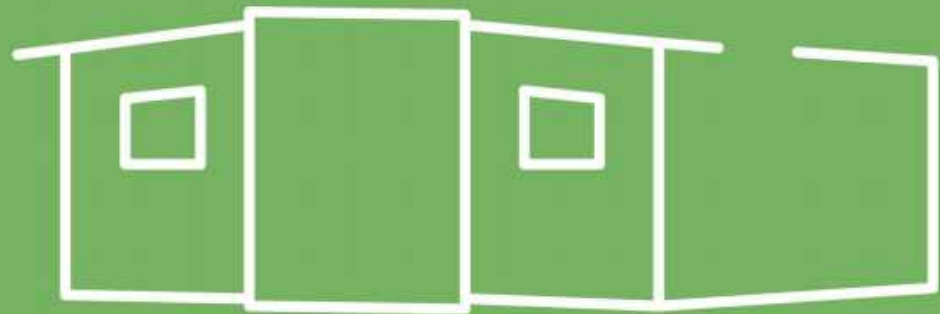

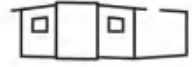

Prefab Modular Container House



10 FT Expandable container specification

Basic characteristic	Outer size(mm)	2950*6200*2480
	Inner size(mm)	2690*6040*2240
	Folded size(mm)	2950*2200*2480
	Weight(kg)	2000
Frame		
Name	Item	Specifications
Main frame (Galvanized steel)	Top side beam	80*100*2.5MM square pipe
	Top beam	Bent part 2.0MM
	Bottom side beam	80*140*2.0MM square pipe
	Bottom beam	Bent part 2.0MM
	Galvanised hanging head	Galvanised hanging head 210*150*160*4.0MM
Flanking frame (Galvanized steel)	Steel columns	Bent part 2.0MM
	Roof frame	40*80*1.5MM P-tube
	Bottom frame	40*80*1.5MM square pipe
Overall frame protection coating	Folding hinge	60*80*1.5MM square pipe
		130MM Galvanised hinges
Roof	Spraying	Electrostatic Spraying
	External ceiling panels	T50MM EPS Colour Steel Sheet + Waterproof Coating
Wallboard	Internal ceiling panels	Type 200 Ceiling Board
	Side walls, front and back walls	T65 MM EPS colour steel plate
Ground level	Internal partition panels	T50 MM EPS colour steel plate
	Main frame	MGO board 18MM
Door and Windows	Wings	Bamboo plywood 18MM
	Pvc sliding window	920*920MM
Electrical system	Steel single door	840*2030MM
	Breaker system	32A leakage protector 1pc: Votage 220V、50HZ 30*30
	Lamp	Flat panel light, large ceiling light
	Socket	Standard with national standard three-hole, five-hole socket (can be configured according to customer needs)
	Light switch	Double open, single key switch (switch standard can be configured according to customer requirements)
	Wiring	Incoming 6 ² , air conditioning sockets 4 ² , general sockets 2.5 ² , lighting 1.5 ² (can be customised to meet certification requirements for circuits according to country)

20 FT Expandable container house





20 FT Two-storey



Structure

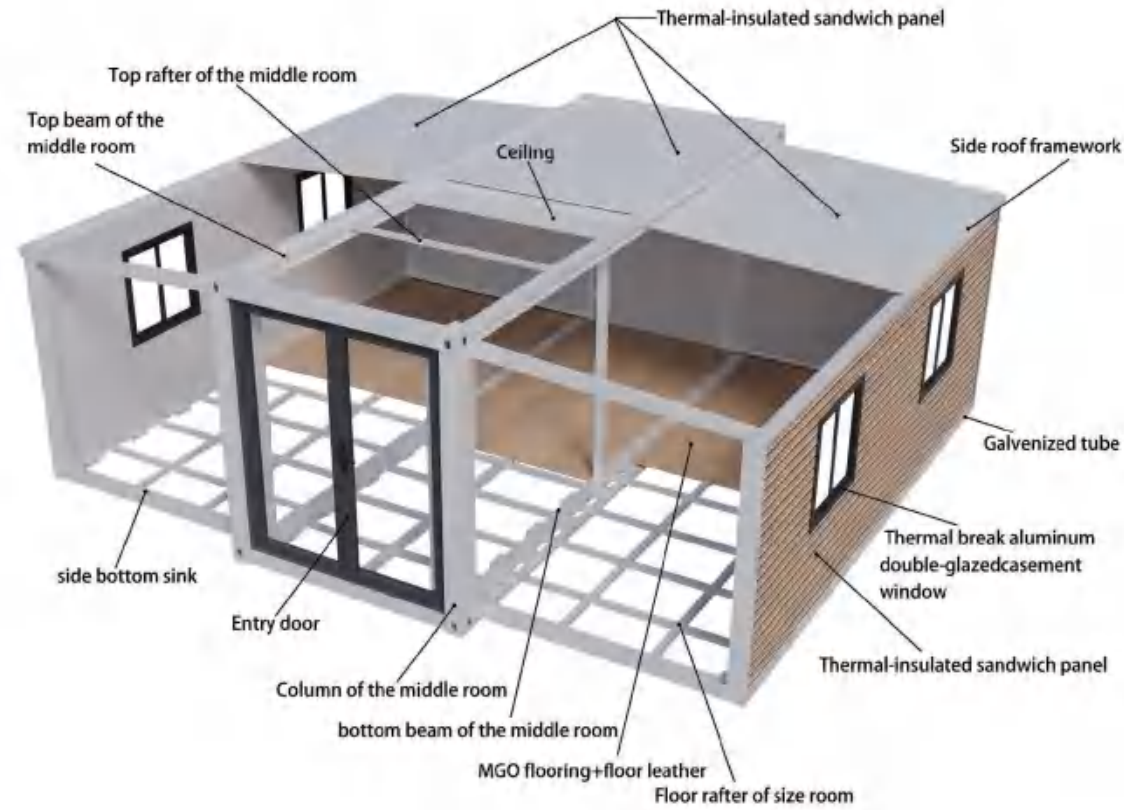

Floor plan



20 FT Expandable container specification

20FT Container	Outer dimensions (L*W*h)	5900*2200*2480mm	Expanded Size (L*W*H)	5900mm*6300mm*2480mm
Targets	Thermal insulation	Entry=0.048W/m-K	Fireproof performance	Wind resistance 0.60kN/m ²
	Soundproofing	Sound insulation ≥30dB	Fire performance	A grade
	Waterproof performance	Organized drainage with 16 mm/min of precipitation without leakage	Anti-seismic performance	Grade 8
	Ground load	2.0kN/m ²	Roof load	0.9kN/W ²
Structures	Main frame	Ground main beam 1: specification 80mm*100mm square steel, galvanized beam 2.0mm thick; ground main beam 2: 180m profiled C-beam, galvanized beam 2.0mm thick		
		Ground secondary beam: specification 60*40*1.5mm thick*9 galvanized square tubes or C-beams		
		Column: 210*150mm, galvanized 2.5mm thick		
		Roof main beam 1: specification 80mm*100mm square steel, galvanized 2.0mm thick; roof main beam 2: 140m shaped C-beam, galvanized beam 2.0mm thick		
Flanking frame	Roof secondary beam 40*40*1.5mm thick*7 galvanized square tubes or U-beams, 20*40*1.2 square tubes*2 or 80U channel*1.5mm thick			
	P80*1.5mm special pipe/P65*1.5mm special pipe/L special galvanized steel sheet, thickness 2.0mm, 50*70*1.5mm Rectangular Pipe/L25*25*1.0 Angle Steel			
Surface treatment	Electrostatic spraying plastic powder baking paint ≥80 Hm			
Wall board	Flame retardant benzene board	Color steel EPS composite board thickness 75mm, width 950mm, color steel plate thickness 0.3mm, PE film attached, color white-gray, inside and outside pure flat without embossed heat insulation board, capacity 12kg/m ³ flame retardant		
Roofing	Roof panel	Roof tile color steel veneer bite/50 thick EPS composite board, thickness 0.3mm, interactive bite. Top with 3 sheets of corrugated board, secondary waterproofing, thickness 0.45mm		
	Insulation layer	EPS thickness 50mm, weight 14kg/m ³ , combustion performance is class A non-combustible		
	Suspended ceiling	831/190 Strip strip ceiling panel, 0.32mm		
Ground	Structural plate	Cement-modified board, 18mm thick, with 2.0mm wood glue boards on both sides		
	Synthetic flooring	Manually applied pvc floor leather, thickness 1.6mm, heat fused caulking		
Door	Entrance door	Broken bridge aluminum folio / Kentucky aluminum alloy folio door / aluminum-magnesium alloy flat / aluminum-magnesium alloy sliding, size ≥W1900mm × H2280mm. Toughened glass. (Alternative one)		
	Interior door	Steel set door, size ≥W840mm × H2040mm, national standard fire door lock		
Window	Window	Broken bridge aluminum casement window/plastic steel casement window/aluminum-magnesium alloy track sliding window, size: W930mm × h930mm (choose one, the number can be customized)		
Electronic	Light	LED round ceiling light 15W/set		
	Socket	European standard, UL standard, Austrian standard, national standard available		
	Switchgear	Single key switch x3 pcs		
	Switching cabinet	Concealed distribution box x 1 pc. (European standard option)		
	Air switch	European standard, American standard, Austrian standard, national standard available		
	CEE industrial plugs	220V, 50Hz, 3P32A x 1 pc		
	wiring	Entry line: 3*6 square, air conditioner socket: 3*4 square, common socket: 3*2.5 square, lighting: 2*1.5 square		
waterproofing		D-shaped adhesive tape for each movable joint; butyl waterproof tape		
Integrated bathroom		Toilet, shower, sink, vent window, supply and drain fittings (optional: empty container not included)		

30 FT Expandable container

Prefab Modular Container House

Great Grande





30FT Expandable container house

Size	Folded dimensions (L*W*H)	9000mm*2200mm*2480mm		
	Unfolded dimensions (L*W*H)	9000mm*6200mm*2480mm		
Standard	Thermal Insulation	Income=0.048w/m-k fireproof performance	Wind Resistance	0.60kN/m ²
	Acoustic performance	Sound insulation ≥30db	Fire resistance	Class A
	Waterproofing	Organized drainage, precipitation 16mm/min without leakage.	Seismic performance	Grade 8
	Ground live load	2.0kN/m ²	Roof Live Load	0.9kN/W ²
Structure	Main structure	Floor main beam: Specification 80mm*140mm square steel, galvanized beam 3.0mm thick		
		Ground secondary beam: specification 60*40*2.0mm thick		
		Column: specification 210*150mm, galvanized 2.5mm thick		
		Roof main beam: specification 80mm*140mm square steel, galvanized 3.0mm thick		
Structure	Side Wing Frames	Roof secondary beam 40*40*1.5mm thick*7 galvanized square tubes or U-beams, 20*40*1.5 square tubes *2		
		P80*2.0mm Special pipe/P65*2.0mm special pipe/L special galvanized steel sheet, Thickness 2.0mm;50*70*2.0mm rectangular pipe/L25*25*1.0 angle steel		
Wallboard	Surface treatment	Electrostatic spraying plastic powder baking paint≥80 Hm		
		Flame Retardant Styrene Board	Color steel EPS composite board thickness 75mm, width 950mm, color steel plate thickness 0.3mm, PE film attached, color white-gray, inside and outside pure flat without embossed heat insulation board, capacity 12kg/m ³ flame retardant	
Roof	Roofing panels	50mm thick EPS composite panel, steel plate thickness 0.3mm. top with corrugated board, secondary waterproofing, thickness 0.4mm		
	Insulation layer	EPS thickness 50mm, weight 14kg/m ³ , combustion performance is class A non-combustible		
	Ceiling	Model 190 Pressure Fastening Board		
Floor	Structural panels	The main floor is magnesium board, thickness 18mm; the two sides of the floor is 18mm wood plywood		
	Vinyl flooring	Pvc floor leather, thickness 2.0mm		
Doors	Entry doors	W1900mmxH2235mm(Thermal aluminum door/Kentucky aluminum door/Aluminum-magnesium alloy swing door/Aluminum-magnesium alloy sliding door)optional		
	Interior doors	W780mmxH2050mm		
Windows	Exterior windows	W930mm×H930mm		
	Lights	LED round ceiling light 15W/set. Bathroom 12W		
Electronic Equipment	Socket	European standard, American standard, Austrian standard, national standard available		
	Switches	Single key switch x 3 pcs. Double switch, single switch		
	Distribution boxes	Concealed power distribution box x 1 pc		
	Air switches	European standard, American standard, Austrian standard, national standard available		
	CEE Industrial plugs	220V,50Hz,3P32A×1 pc		
	Wiring	Entry line: 3*6 square, air conditioner socket: 3*4 square, common socket: 3*2.5 square, lighting: 2*1.5 square		
Waterproofing		D-shaped adhesive tape for each movable joint; butyl waterproof tape		
Integrated bathroom		Toilet, shower, sink, vent window, supply and drain fittings (optional: empty box not included)		
	Separate wet and dry bathroom	Sliding door		

40 FT Expandable container





Great Grande

Grande house china famous folding house, foldable house factory

Every panel whispers
'welcome home'





40FT Expandable container house parameters

Extension size	11800mm*6220mm*2480mm	Folded size	11800*2200*2480mm
External area	73.4m ²	Interior area	72m ²
Water resistance	Precipitation 16mm/min, no leakage	Fire resistance	Level A
Ground live load	2.0 kN/m ²	Roof live load	0.9 kN/m ²
Frame structure	Main frame	Top main beam:	80mm*140mm*3.0mm
		Roof purlin	40mm*40mm*1.5mm,20mm*40mm tube*2pcs
		Bottom main beam:	80mm*140mm*3mm
		Bottom side beam:	80mm*80mm*2.0mm
		Pillar	210mm*150mm*2.5mm
	Side frame	Top frame	40mm*80mm*1.5mm
		Bottom frame	60mm*80mm*2.0mm
Folding hinge		130mm	
Surface treatment	Electrostatic spraying plastic powder baking paint≥80 Hm		
Wall panel	Outer wall 75mm EPS color steel title sandwich panel+partition inner wall 50mm EPS color steel title sandwich panel		
Roof	1st layer-0.4mm Corrugated color steel title for 2nd water proof		
	2nd layer-50mm EPS sandwich panel with 0.3mm color steel title		
	3rd layer-roof steel structure		
	4th layer-200 style ceiling panel/50mm integrated grapheen EPS bamboo wood fiber ceiling		
Ground	18mm MGO/Cement fiber/plywood		
Floor	2.0mm PVC floor		
Electric systems	Lamp	LED ceiling light, super slim at two sides, surface light at middle	
	Socket	According to different country Standards	
	Switch	Single switch	
	Distribution box	Concealed distribution box×1. (USAstANDARD alternative)	
	AC Socket	According to different country Standards	
	CE Industrial Plug	220V, 50Hz, 3P32A×1.	
	Wiring (load bearing 12KW/h)	Entry line: 3*6 square meters, air conditioning socket: 3*4 square meters, ordinary socket: 3*2.5 square meters, lighting: 2*1.5 square meters.	





700 Model expandable container house





700 Model expandable container house specifications

	Outer dimensions (L*W*H)	5900*700*2480mm		
	Expanded size (L*W*H)	5900mm*4800mm*2480mm		
Targets	Thermal insulation	Entry=0.048W/m-K	Fireproof performance	Wind resistance 0.60kN/m ²
	Soundproofing	Sound insulation ≥30dB		Fire performance A grade
	Waterproof performance	Organized drainage with 16 mm/min of precipitation without leakage		Anti-seismic performance Grade 8
	Ground load	2.0kN/m ²	Roof load	0.9kN/W ²
Structure	Main frame	Ground main beam: specification 80mm*100mm square steel, galvanised beam 2mm thick		
		Ground secondary beam: specification 60*40*1.5mm thick galvanised square tube		
		Column: specification 210*150mm, galvanised 2mm thick		
		Roof main beam: specification 80mm*100mm square steel, galvanised 2mm thick		
		Roof secondary beam 40*40*1.2mm thick*7 galvanised square tubes or U-beams, 20 *40*1.2 square tubes*2pcs		
	Flanking frame	Concave tube*1.2mm special tube		
	Surface treatment	Electrostatic spraying plastic powder baking paint ≥80 Hm		
Wall panel	Flame retardant benzene board	Colour steel EPS composite panel thickness 75mm, width 950mm, colour steel plate thickness 0.3mm, colour white-grey, inside and outside pure flat non-embossed heat insulation panel		
Roofing	Roof pane	50 thick EPS composite panel, steel plate thickness 0.3mm, top with corrugated board, secondary waterproofing, thickness 0.3mm		
	Insulation layer	EPS thickness 50mm		
	Ceiling	200 type press type fastening plate		
Ground	Structural board	The main floor is magnesium glass board, 18mm thick		
	PVC floor	pvc floor leather, thickness 2.0mm		
Door	Entrance door	Broken bridge aluminium folio/Kentucky aluminium alloy folio/aluminium-magnesium alloy casement/aluminium-magnesium alloy sliding, size ≥W1900mm × H2230mm, tempered glass. Alternative one toughened glass. (Alternative one)		
Windows	Window	Broken bridge aluminium casement window/plastic steel casement window/aluminium-magnesium alloy track sliding window, size: W930mm × h930mm (choose one, quantity can be customized)		
Electrical system	Lamp	LED round ceiling light 15W/set. Bathroom 12W		
	Sockets	European standard, American standard, Austrian standard and national standard are available		
	Switch	Double open, single open		
	Switching cabinet	Concealed distribution box x 1. With leakage protector x 1. Air switch x 4		
	CEE Industrial plugs	220V, 50Hz, 3P64A × 1		
	Wiring	Entry line: 3*6 square, air-conditioner socket: 3*4 square, common socket: 3*2.5 square, lighting: 2*1.5 square		
Waterproofing		D-shaped adhesive tape for each movable joint; butyl waterproof tape		

Project case

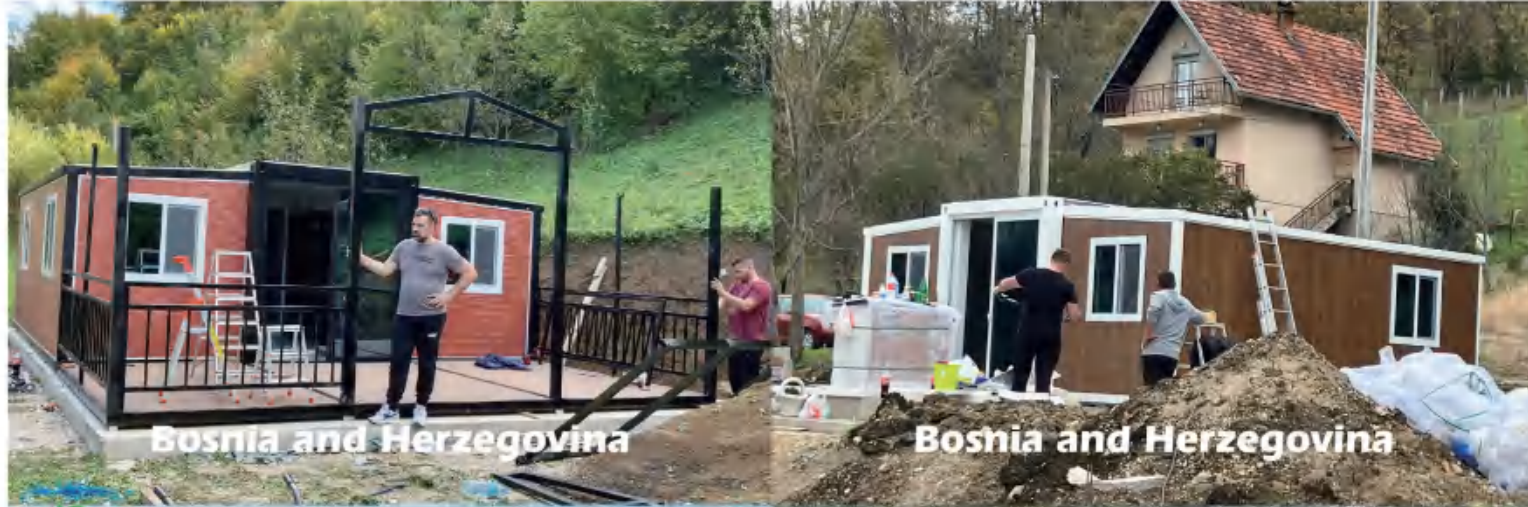

Packing & Shipping



Steps

One 40HC can fit 2 x 20ft expandable house

Or fit 1 x 40ft expandable house

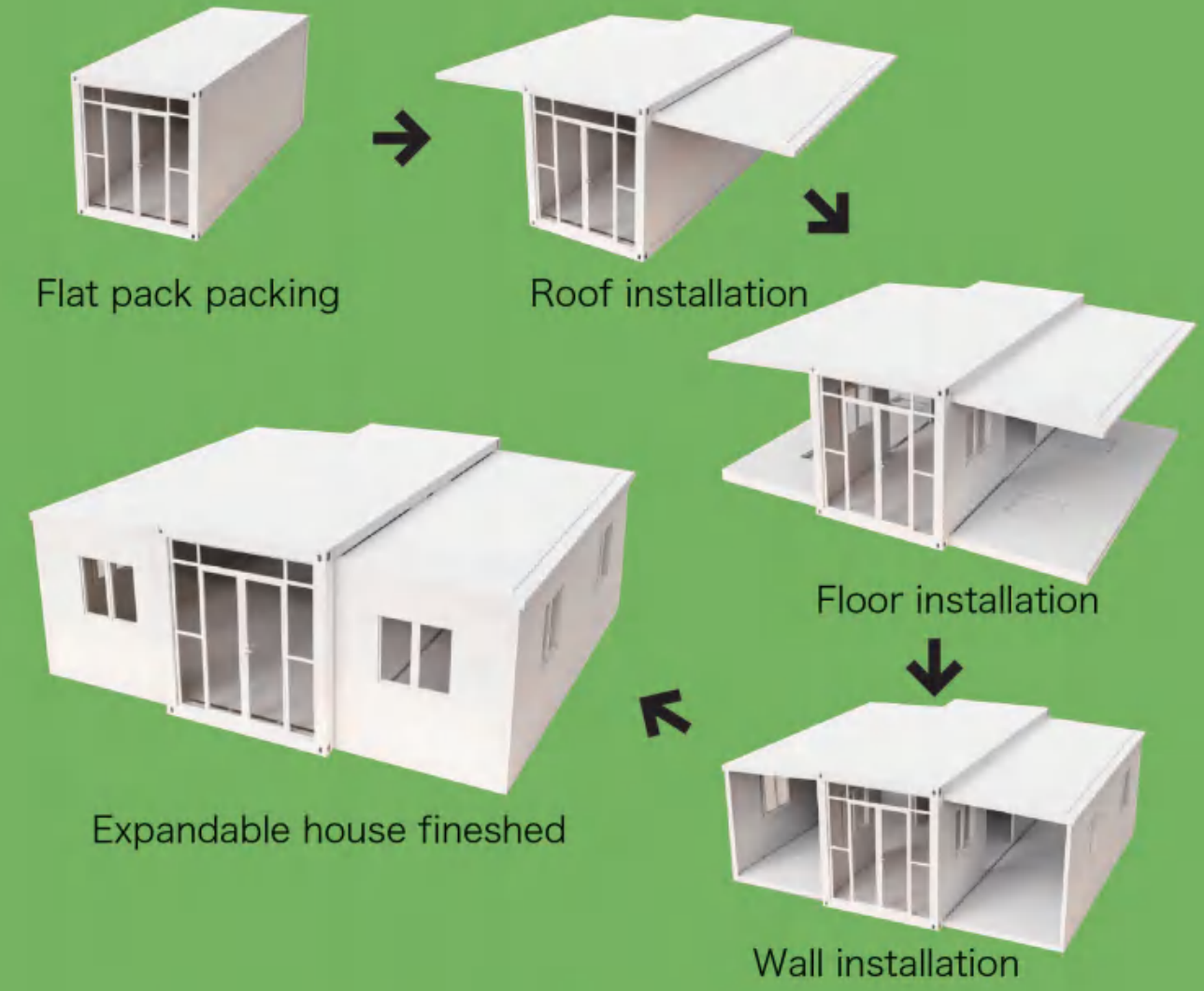

Easy installation: 4 workers 10 mins = 1 house

Folding Container House

Prefab modular container house



Foldable container house

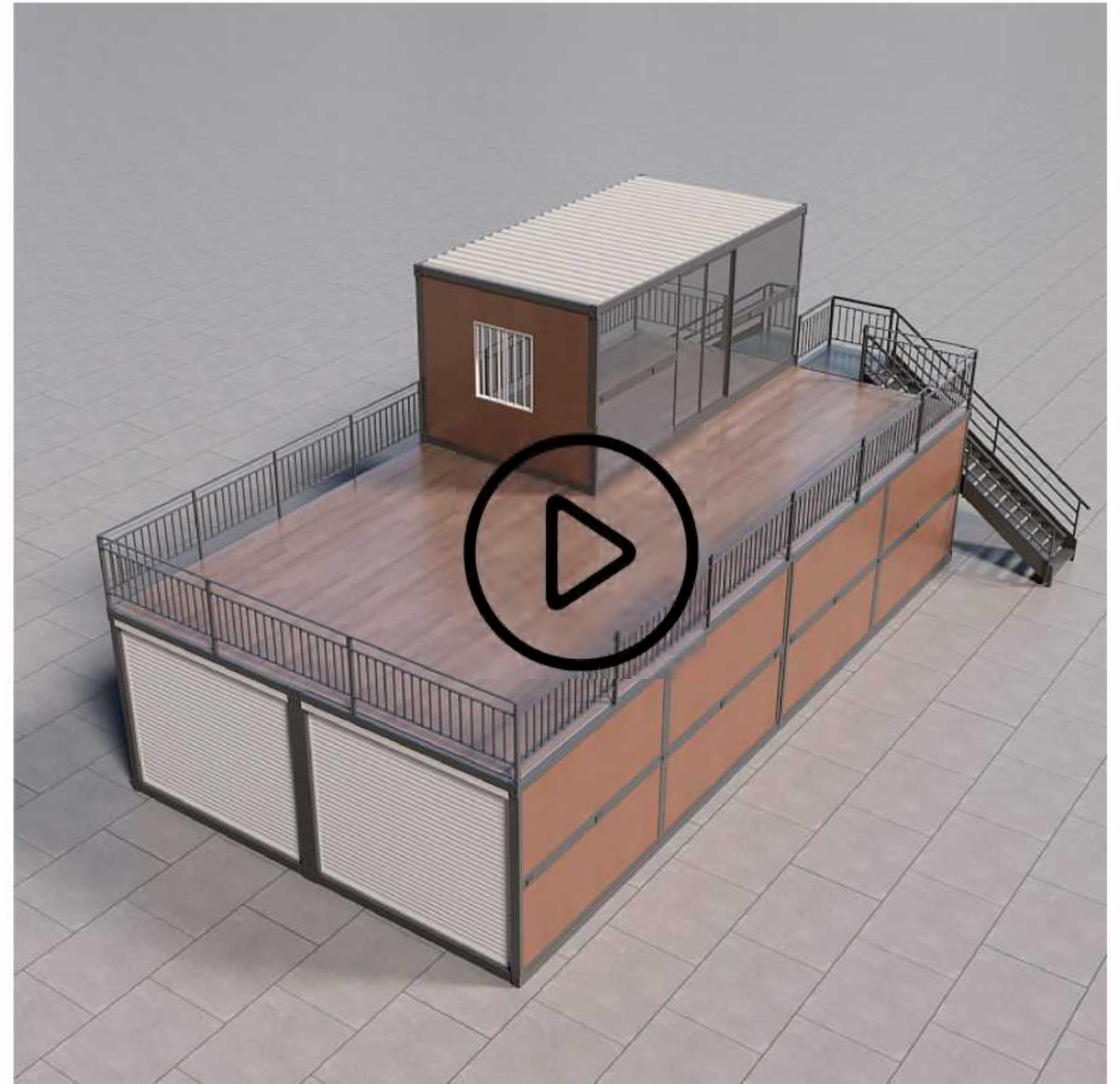



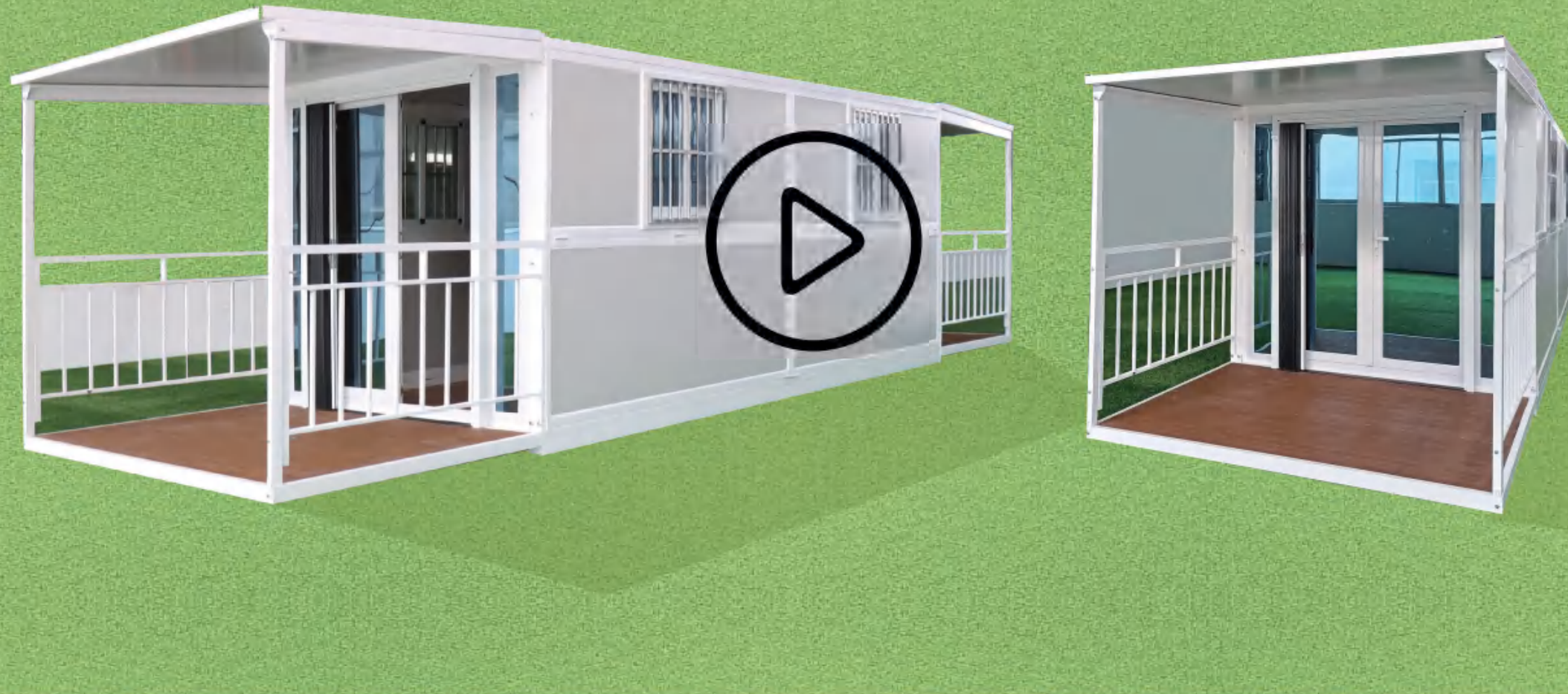



Layout

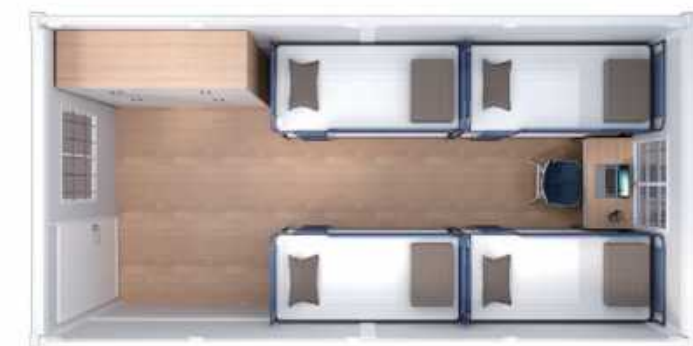

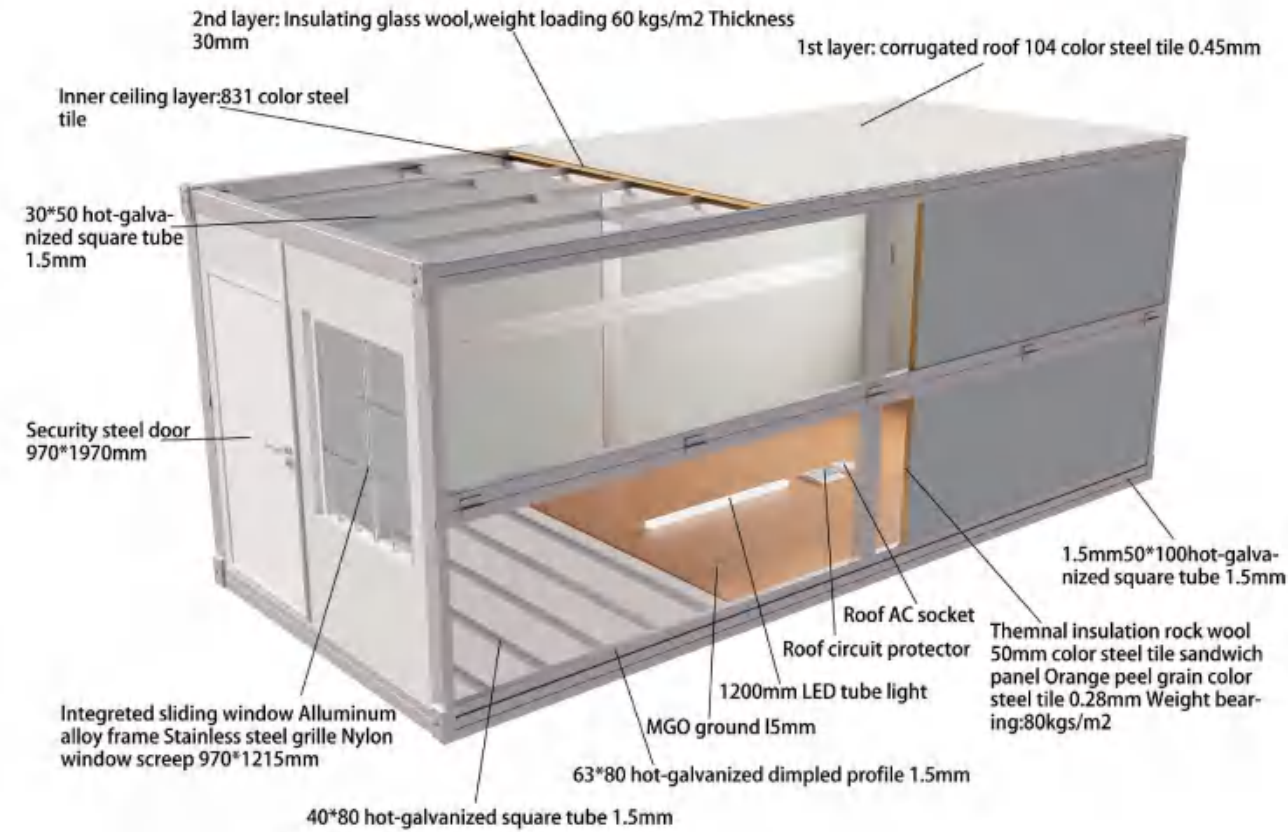

Technical parameters

Types	Items	Specification			
X Folding	External dimensions(mm) (L*W*H)	5800*2500*2390			
	Internal size(mm)	5635*2370*2265			
	Folding state(mm)	5800*2500*360			
	Total mass(kg)	1100			
Frame structure	Top girder	Special shaped steel galvanized concave convex pipe 63mm*80mm*1.5mm			
	Bottom girder	Galvanized square pipe 40mm*60mm			
		Special shaped steel galvanized concave convex pipe 63mm*80mm*1.5mm			
	Top beam	Galvanized square pipe 50mm*50mm*1.5mm			
	Top sub-beam	Galvanized square pipe 30mm*50mm*1.5mm			
	Upper side of front and rear main beam	Galvanized square pipe 60mm*60mm*1.5mm			
	Lower side of front and rear main beam	Special shaped steel galvanized concave convex pipe 63mm*80mm*1.5mm			
	Sidewall frame	Special shaped steel galvanized concave convex pipe 63mm*80mm*1.5			
		Galvanized square steel pipe 40mm*40mm*1.5mm			
	Bottom crossbeam	Galvanized square steel pipe 40mm*40mm*1.5mm			
	Column	Galvanized steel pipe 120mm*55mm*2.2mm			
	Side wall column	Galvanized steel pipe with U-shaped groove 150mm*62mm*1.5mm			
	Top hanging head	Steel plate (180mm*100mm*15mm)			
	Bottom hanging head	Steel plate (210mm*100mm*15mm)			
	304 stainless steel hinge	High-strength galvanized hinge 85mm*115mm*3mm (Shaft column 304 stainless steel)			
	Integral frame protective coating	Cabaret high gloss enamel			
Top of container	External roof	1040 Color steel tile (0.45mm)			
	Internal ceiling	831 Ceiling tile (0.28mm)			
	Insulation glass wool	Bulk density 60kg/m ³ (30mm)			
Wall panel	Heat insulation rock wool color steel composite sandwich panel (side wall)	0.28mm color steel plate/50mm/65kg/m ³ rock wool			
	Heat insulation rock wool color steel composite sandwich panel (Front and rear walls)	0.28mm color steel plate/50mm/65kg/m ³ rock wool			
Floor	MGO fireproof floor	15mm in thickness 1.6mm adhesive			
Security door	Special anti-theft door for folding container	1 set steel door 970mm*1970mm			
Window	Aluminum alloy anti-theft integrated window sliding series(push-pull series)	2 set window 970mm*1215mm Plastic steel double tempered glass 4+5+4mm			
Electrical system	1 Circuit protector, 2 american standard sockets (110V), 5 ceiling LED lights, 1 special socket for air conditioning (3 holes), 1 light switch				
Roofing bearing	0.5KN/m ²	Walkway bearing	1.5KN/m ²	Wall pressure	0.8KN/m ²
Fire rating	A Level	Seismic grade	10 Level	Wind loading	0.45KN/m ²

Steps

1



Hook up

2



Lift up

3



Flip up

4



Set up

Portable container house

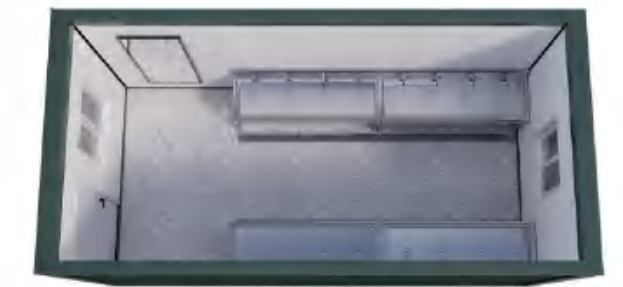



Layout

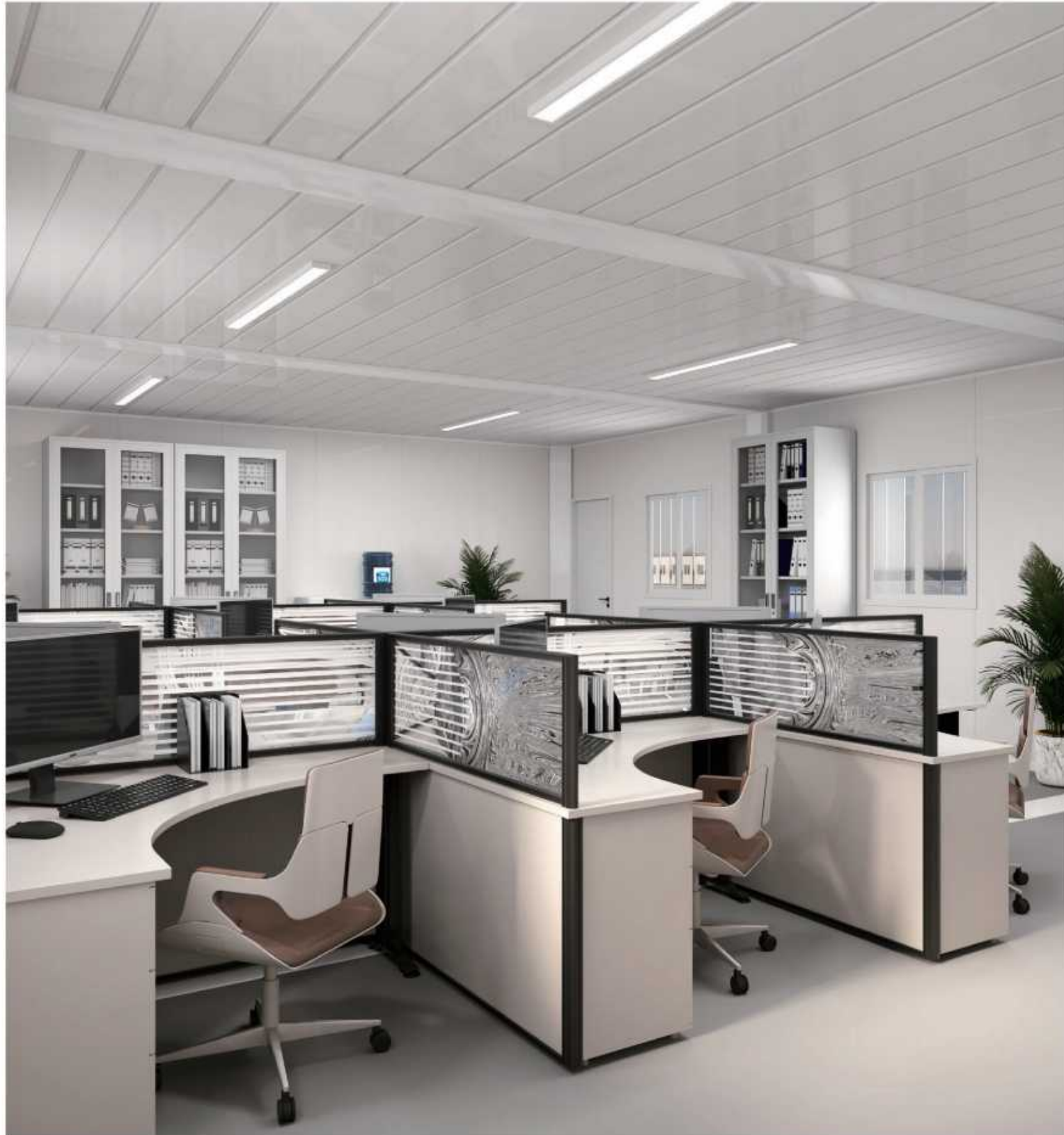

Great Grande

Prefab Modular Container House



Detachable container house parameters

Standard	House size	5.95x3x2.8m	Std. Container size	5.95x3x2.8m			Container qty. 1			
Item	Name	Part	Texture	Std. Qty.	Package	Unit	L (m)	W (cm)	H (cm)	T (mm)
Frame	Bottom beam	Length	Galvanized C profiled steel	2	1	pc	5.63	15	15	2.1
		Width		2	1	pc	2.68	15	15	2.1
	Roof beam	Length		2	1	pc	5.63	15	15	2.1
		Width		2	1	pc	2.68	15	15	2.1
	Column	Vertical		4	4	pc	2.48	16	16	2.15
Corner fitting	Corner	8	8	pc	0.25	24.5	24.5	3.5		
Galvanized square tube steel purlins	Bottom	Primary-purlin	Galvanized square tube steel	9	9	pc	2.99	10.00	5.00	1.1
		Primary-purlin		2	2	pc	2.79	5.00	5.00	1.5
	Top	Secondary-purlin		3	3	pc	1.87	4.00	8.00	1.1
		Secondary-purlin		6	6	pc	1.87	4.00	6.00	1.1
Wall panel	Eps foam board	Wall	Bake painting steel +EPS FOAM	15	15	pc	/	95	255	50
		door plank		2	2	pc	/	95	135	50
		Window panel		1	1	pc	/	95	48	50
Supporting channel bar	Supporting channel bar	Length	Galvanized steel	2	2	pc	5.77	9	3	0.9
		Width		2	2	pc	2.79	9	3	0.9
Enhance beam	Door fram beam	Side of door	Galvanized square tube steel	1	1	pc	2.55	2	4	1
	Wind-proof beam	Middle of frame	Bake painting steel	2	2	pc	2.48	4	6	1
Security door	Doorknob	In&Outdoor	Bake painting steel +Rock wool	1	1	set	2.1	95	5	50
Window	Security window	Security window	security window	2	2	set	1.2	95	5	50
Roof tile	External roof	Outdoor	Galvanized steel sheet tile	6	6	pc	2.96	106	/	0.34
	Ceiling roof	Indoor		6	6	pc	2.78	106	/	0.18
Corner trimming	Corner trimming	Indoor corner	Corner trimming	2	2	pc	5.7	4	4	0.4
				2	2	pc	2.7	4	4	0.4
				4	4	pc	2.5	4	4	0.4
Floor panel	Fire-proof board	Indoor	MGO board	5	5	pc	2.8	114.7	/	15
Finding	Glass fiber wool	Under roof tile	Glass fiber wool	1	1	set	20	120	/	30
	Sealing strip			1	1	pc				
	Structure adhesive			4	1	pc				



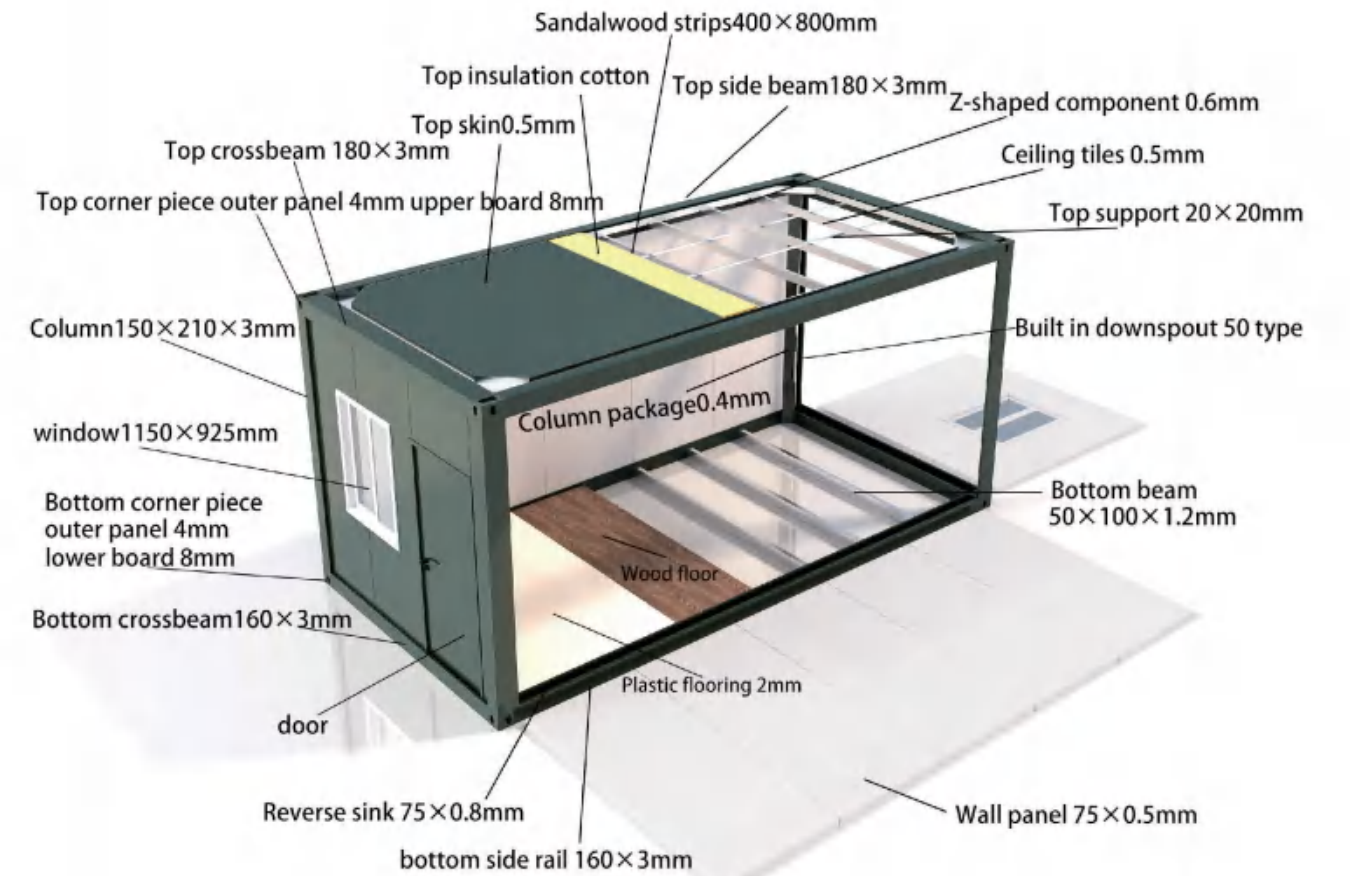
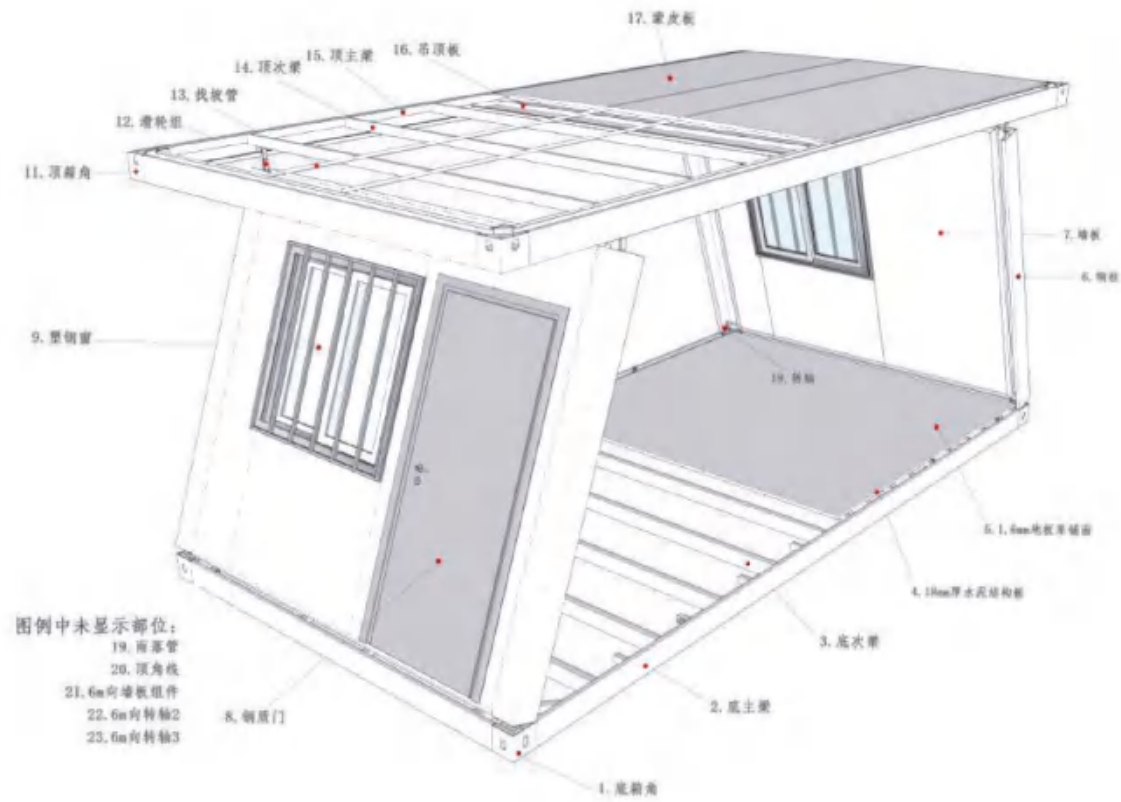
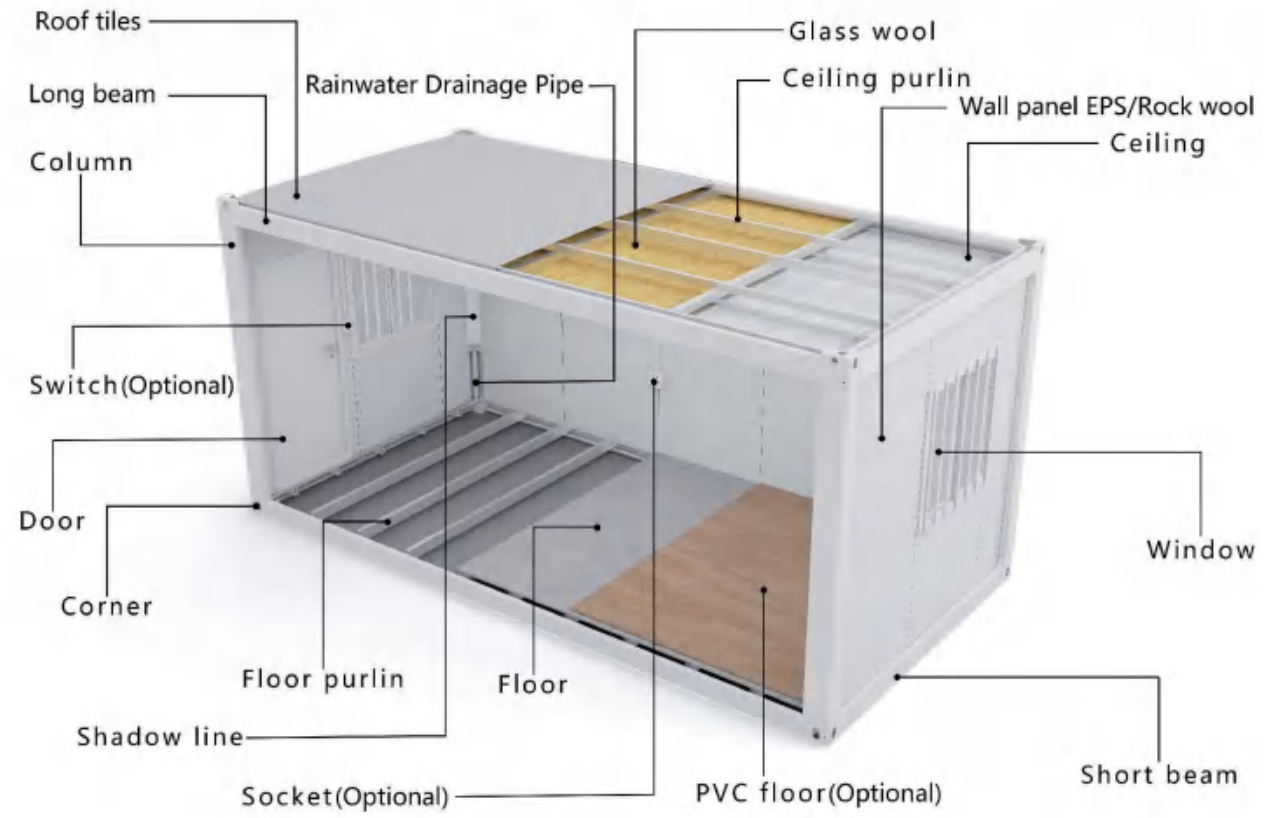

Project case





Packing & Shipping

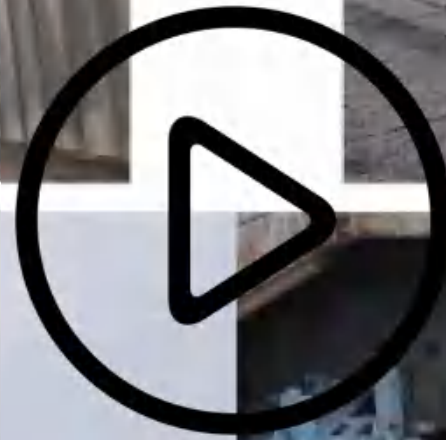

Metal carved board

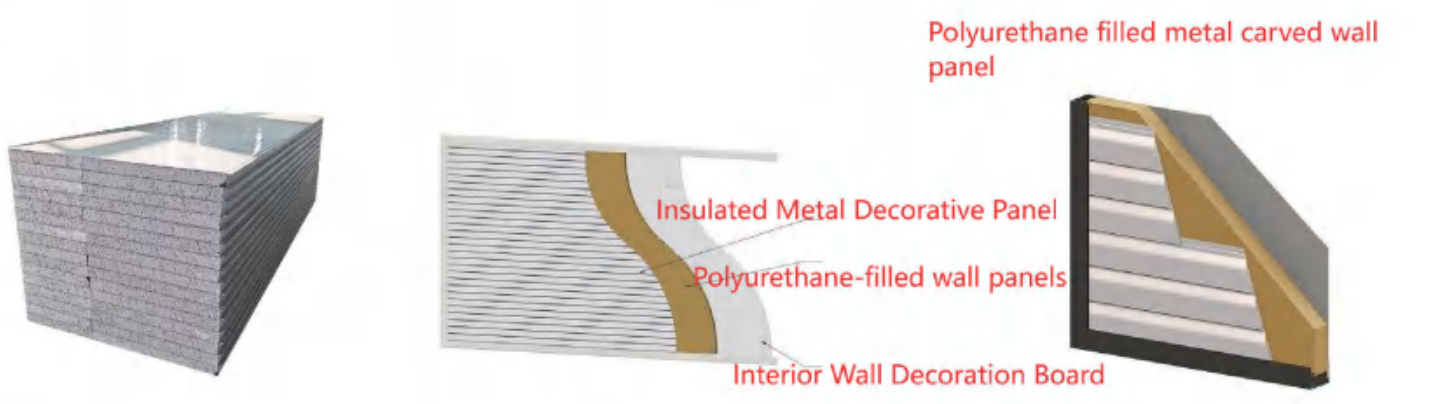
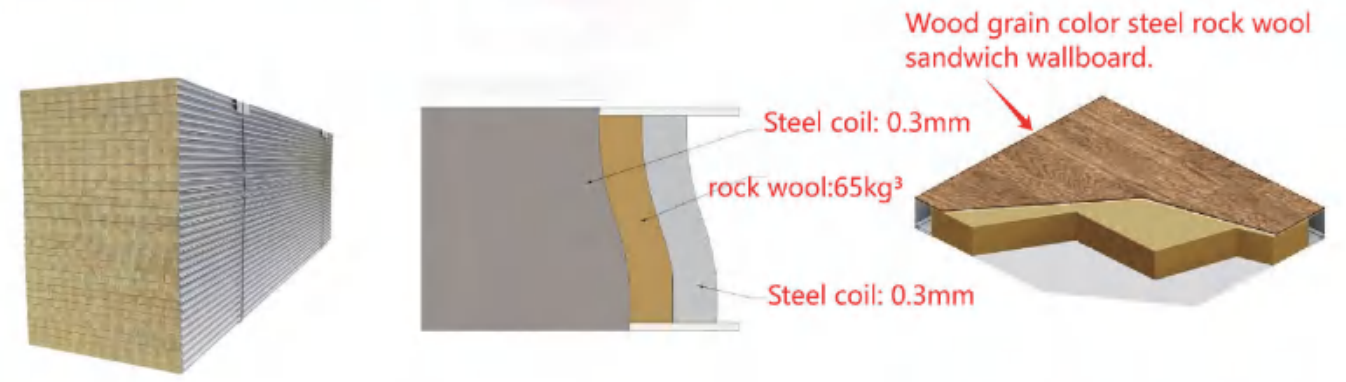

Bamboo-wood fiber internal wallboard



Carbon crystal inner wall panel



SPC floor leather



PVC floor leather

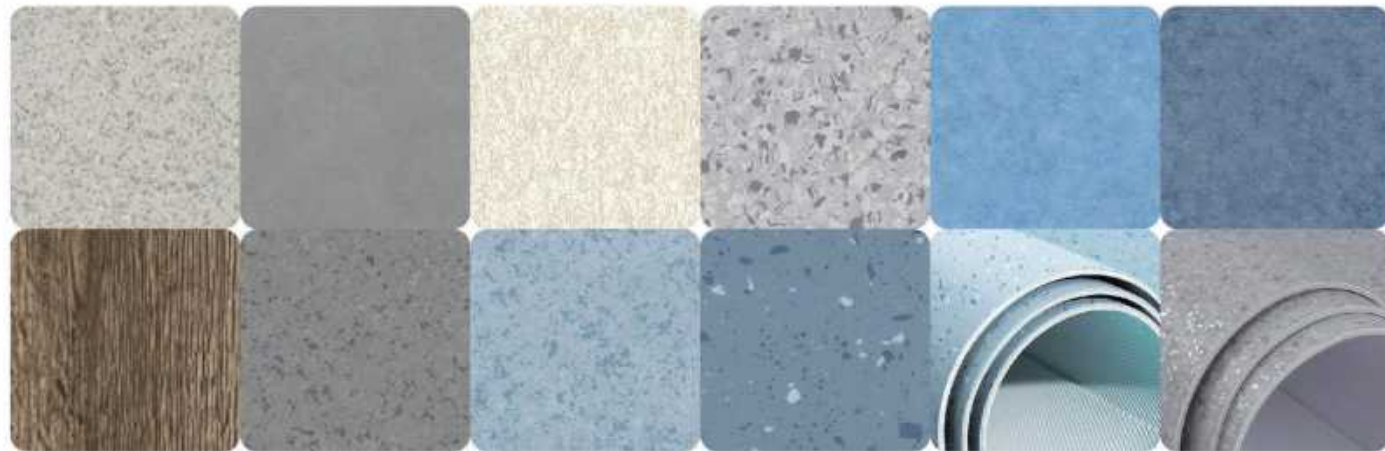

Plastic-wood composite floor



Skirting line



Circuit breaker style



Switch style



Socket style



Kitchen

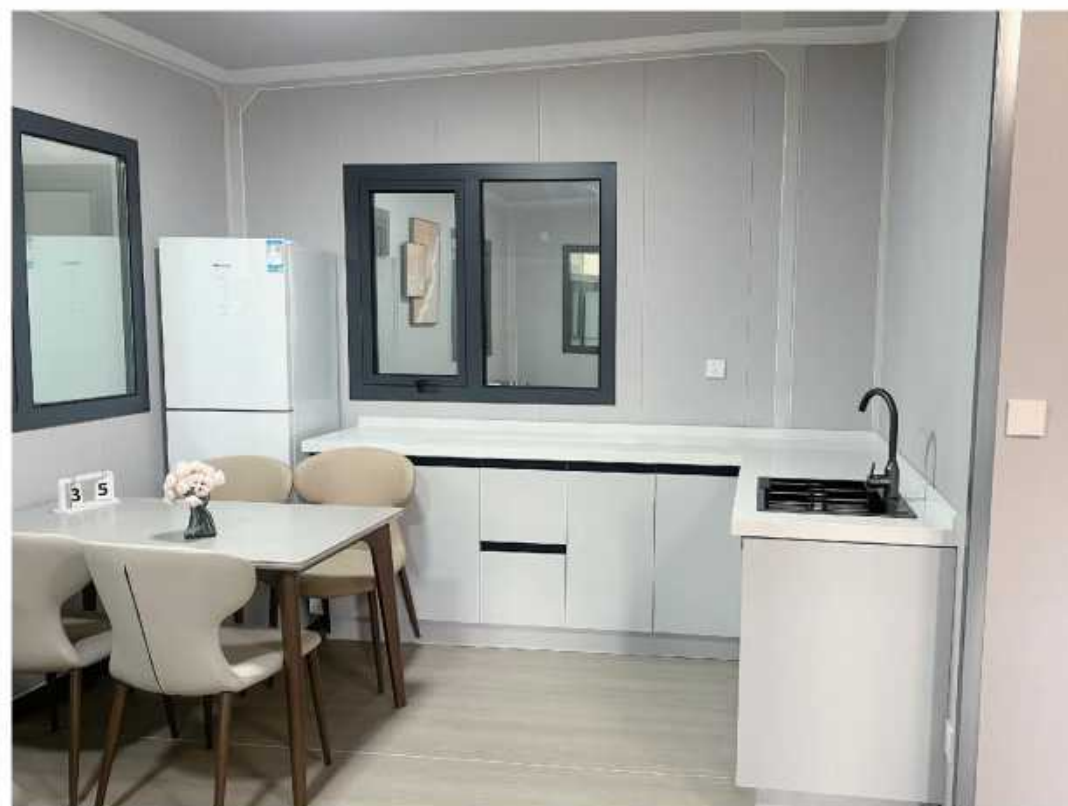
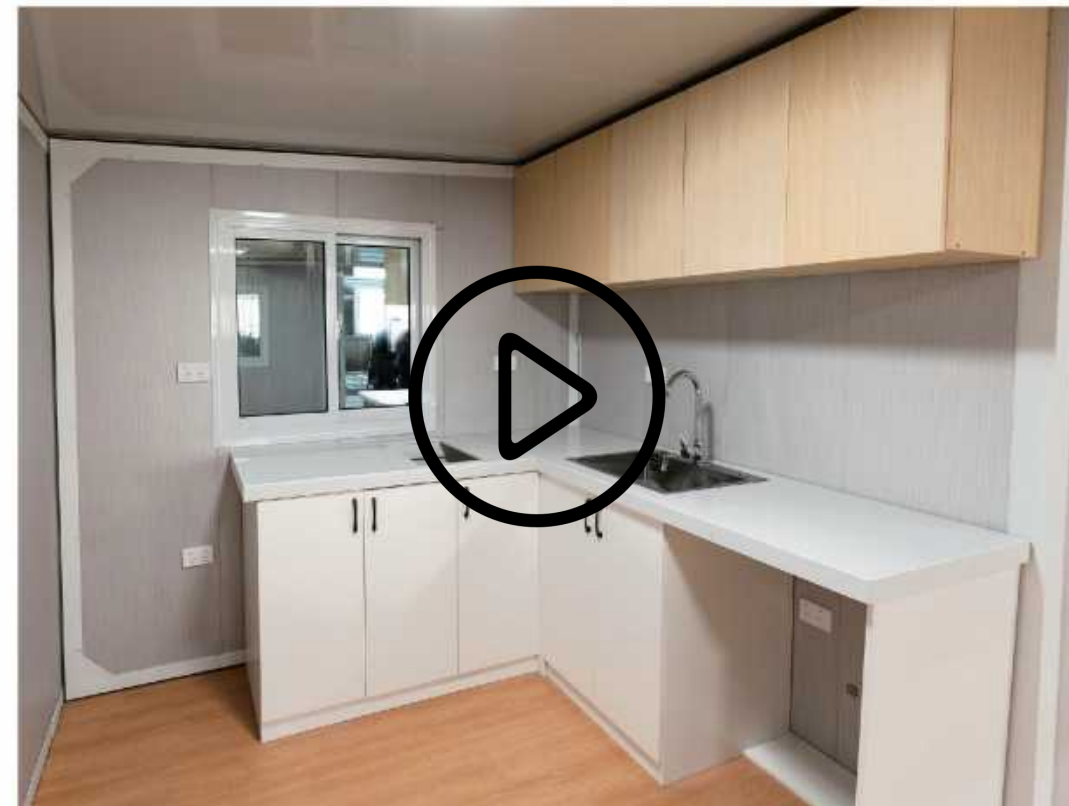
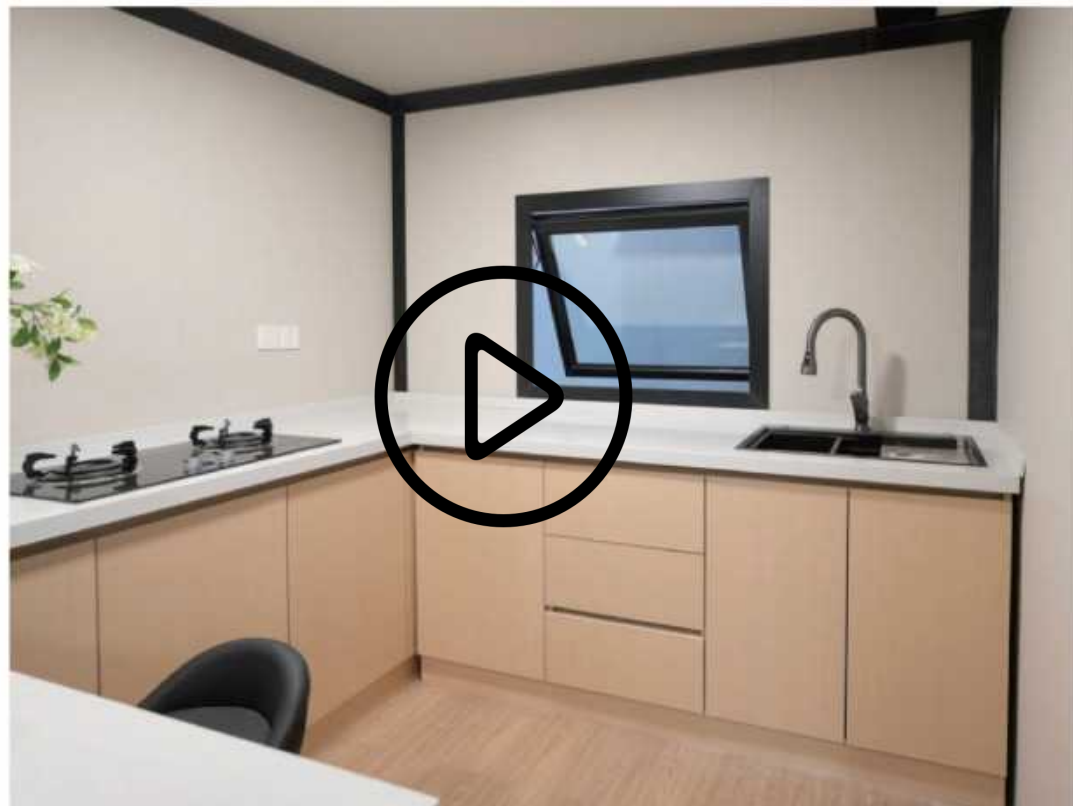

Bathroom

Grande house china famous folding house, foldable house factory



Door&Window

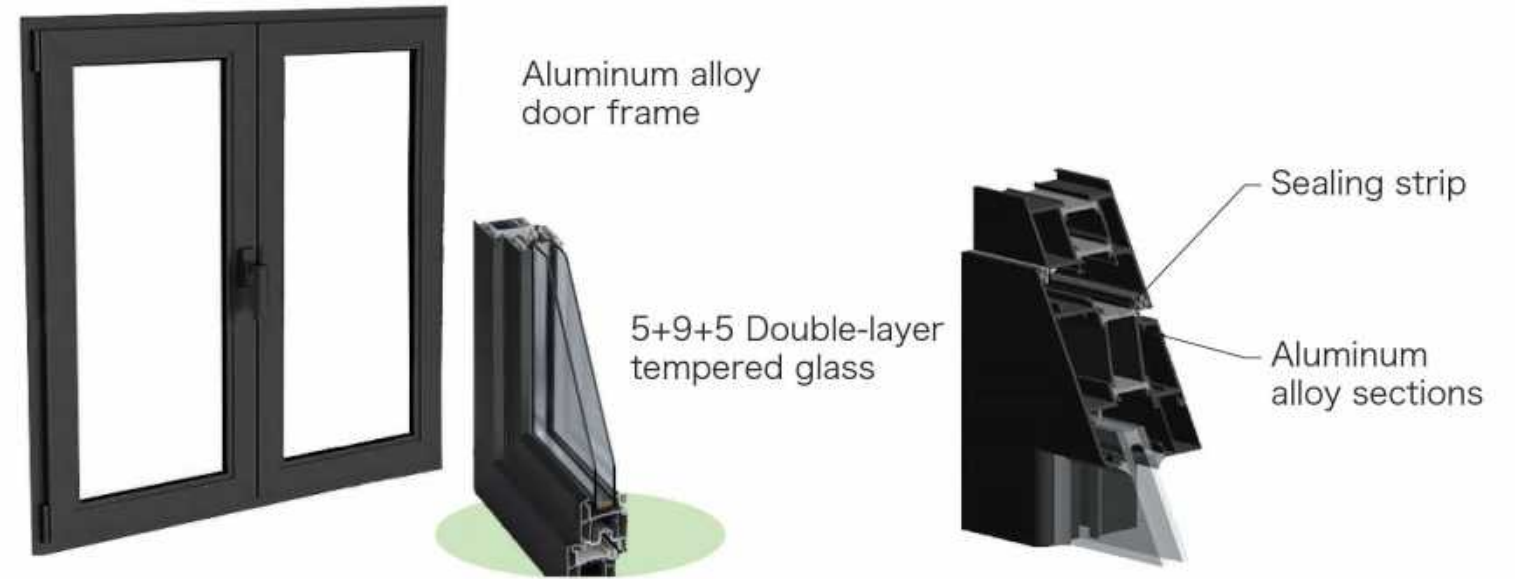
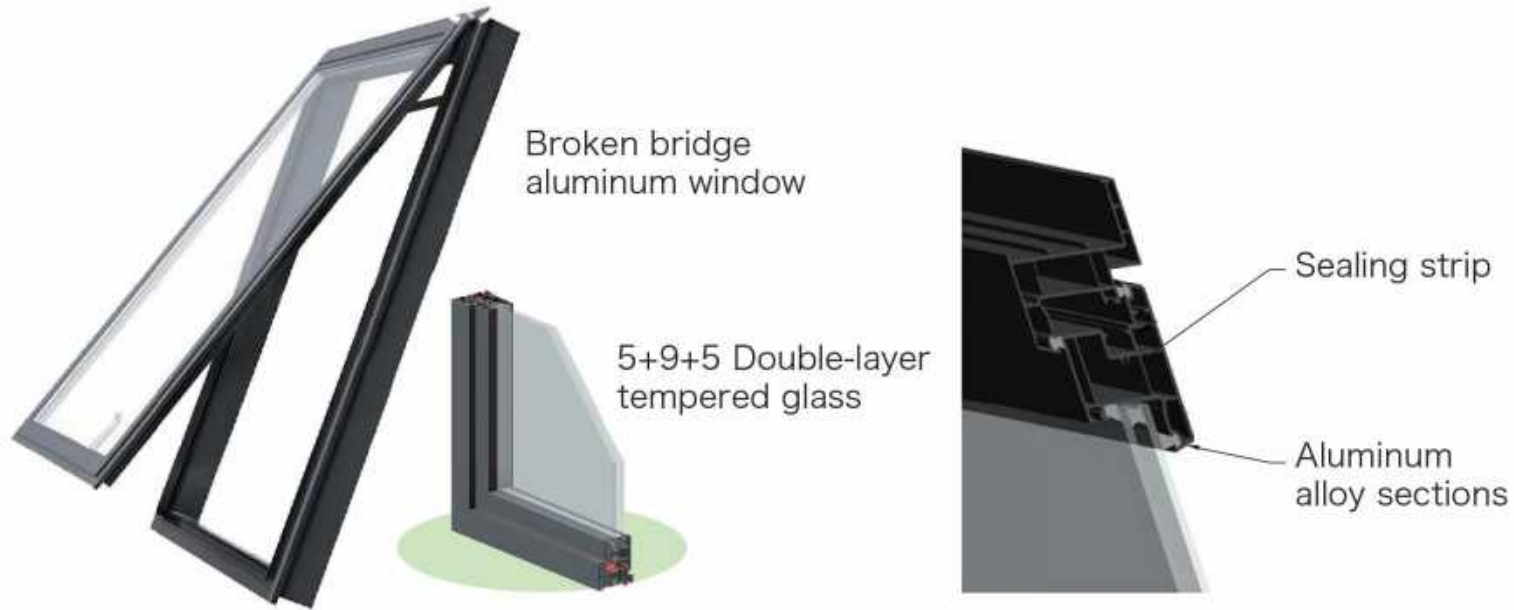

Terrace

Grande modular house in china | innovative folding homes
Factory-customizable, durable & space-smart



Outdoor toilet



Space Capsule

Prefab modular container house

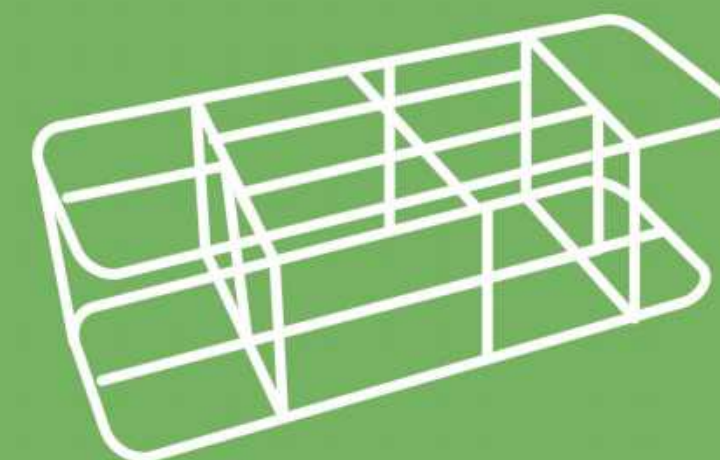

Space capsule

The appearance of the spacecraft house is novel and full of technological sense. It adopts the overall framework streamline is simple and clear. The overall layout has become a classic example of high-end camping accommodation products in the industry, suitable for a wide range of scenarios and is a choice for tourism and vacation.



Prefab Modular
Container House

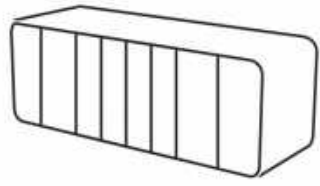

Apple cabin

As a new generation of intelligent mobile travel products, Apple cabin has a simple and elegant appearance, perfectly integrating with nature. The indoor layout is spacious, natural and comfortable, with a fully galvanized steel frame and aviation aluminum shell. The structure is beautiful, the shape is avant-garde, and it is easy to assemble. It can be used as a venue for office, catering, homestay and other facilities.



Triangle house

